



STAIRS PUMPS

STAIRS
SP SERIES
STAINLESS STEEL
SUBMERSIBLE PUMPS

50Hz

www.stairs.com.tw

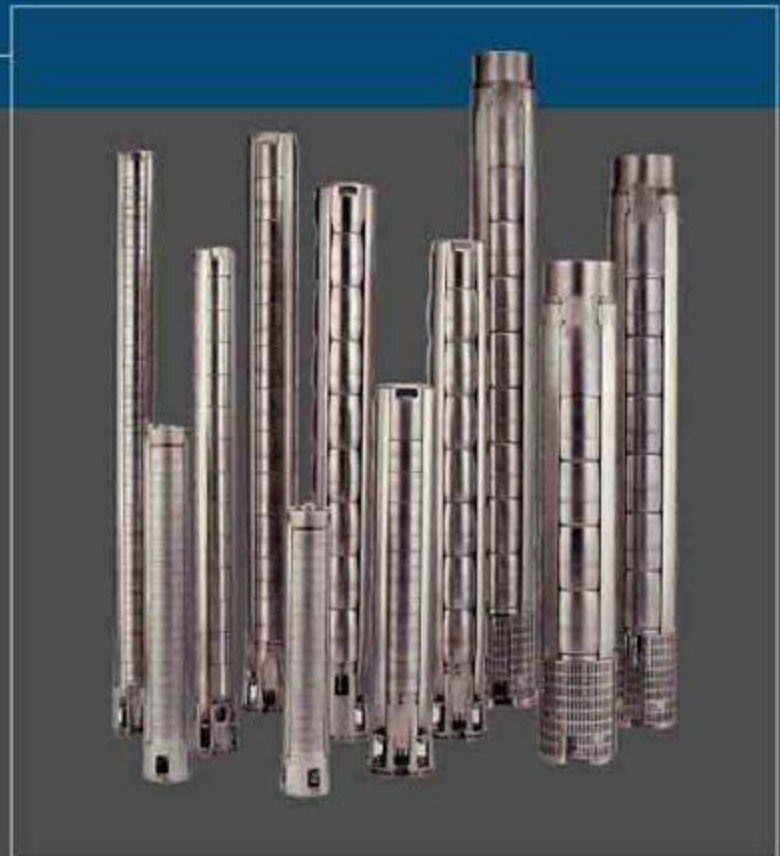

STAIRS INDUSTRIAL CO., LTD.

Stairs **SP** Series



STAIRS PUMPS

Index

General Data

Performance Range	2
Material Specification	3
4" Submersible Pumps	6
6" Submersible Pumps	7
8" Submersible Pumps	8

Performance Curves/Technical Data

Series SP05	9
Series SP10	11
Series SP18	13
Series SP25	15
Series SP40	17
Series SP70	19
Series SP90	21
Series SP150	23
Series SP230	25
Series SP300	27
Series SP400	29
Series SP500	31

SP Series 4", 6", 8" Stainless Steel Submersible Pumps

SP 4", 6" and 8" submersible pumps are made of corrosion and abrasion resistant stainless steel and have been developed in accordance with state-of-the-art technology. The SP series of pumps are manufactured to the highest standards for energy efficiency, dependable performance, rugged construction and long service life for the most demanding applications.

Performance range

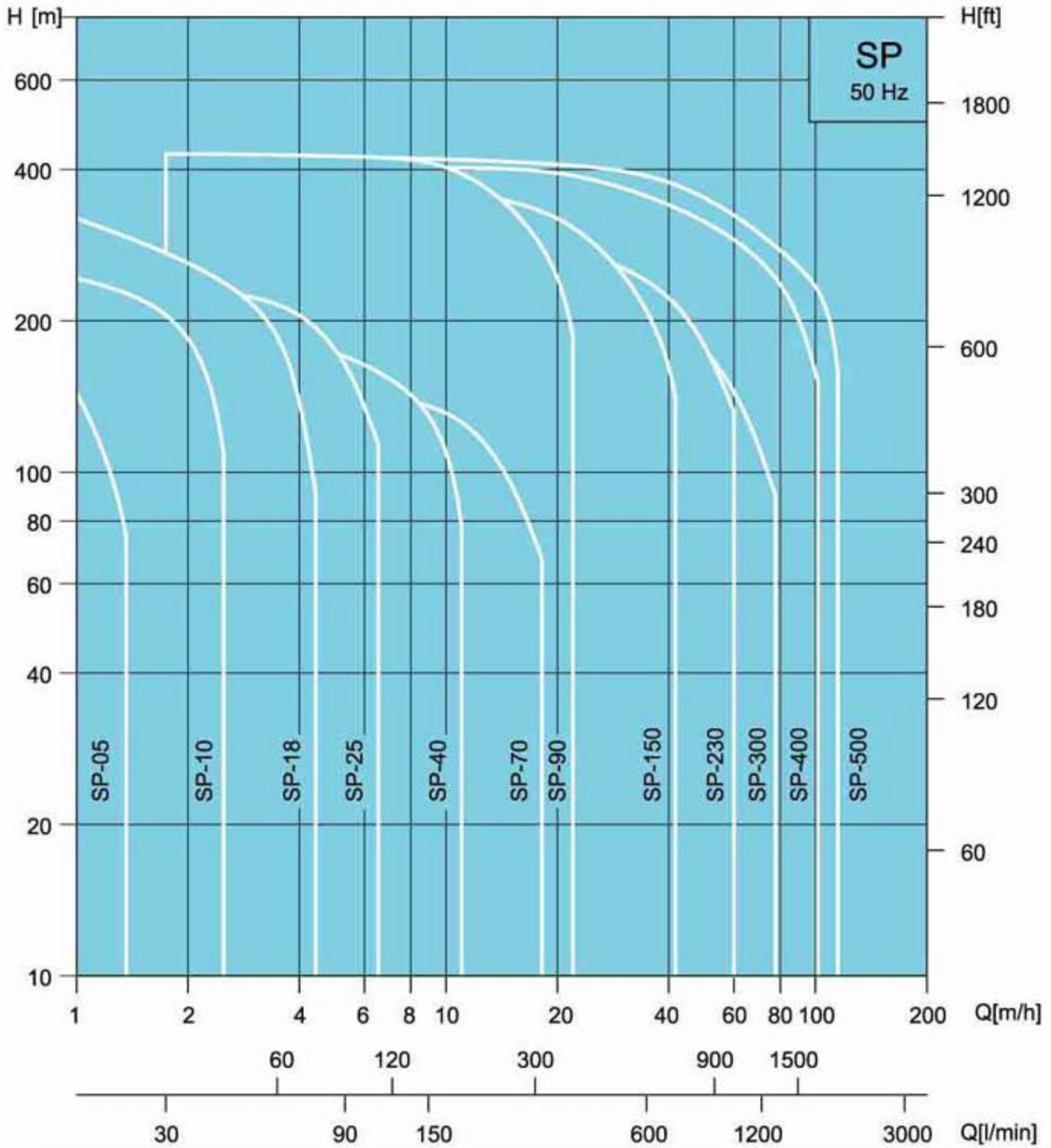

General Data



Example: SP-70

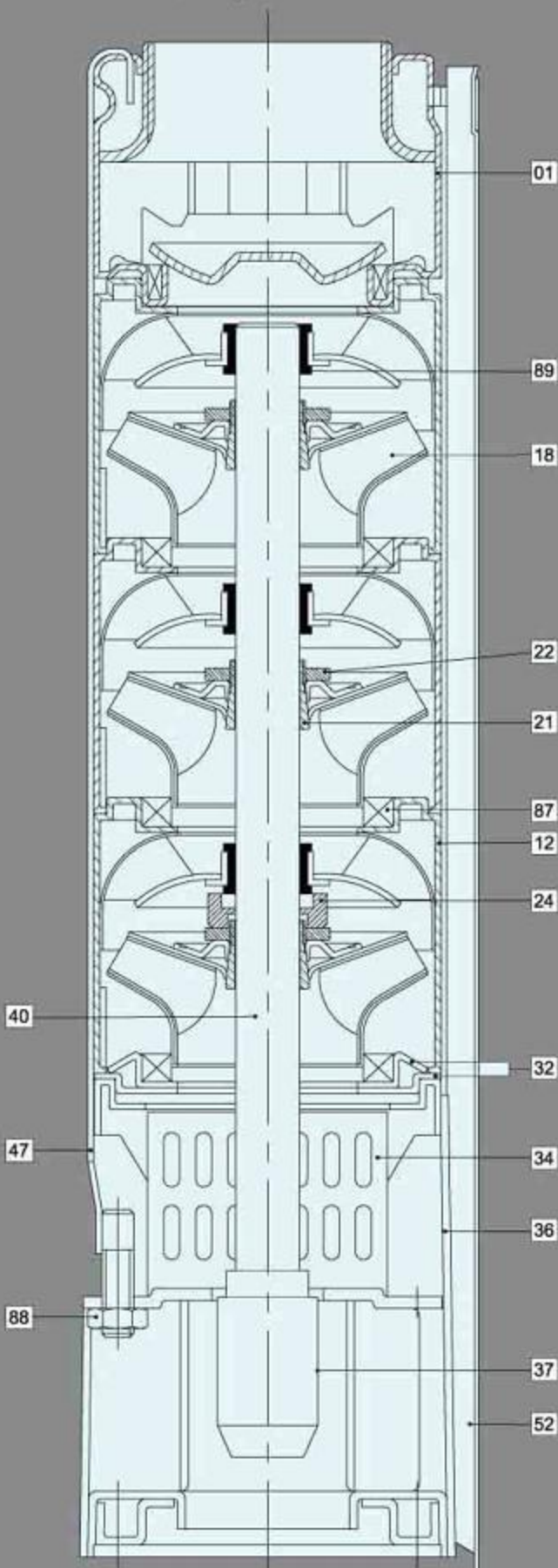

Material Specification-4" Pumps

Pos.	Components	Material	Standard
01	Discharge	Stainless Steel	304
12	Diffuser	Stainless Steel	304
18	Impeller	Stainless Steel	304
21	Split Cone	Stainless Steel	304
22	Split Cone Nut	Stainless Steel	304
24	Stop Ring	Carbon/ Graphite/PTFE	
32	Neck Ring Retainer	Stainless Steel	304
34	Strainer	Stainless Steel	304
36	Suction Interconnector	Stainless Steel	304
40	Pump Shaft	Stainless Steel	431
37	Coupling	Stainless Steel	304
47	Strap	Stainless Steel	304
52	Cable Guard	Stainless Steel	304
87	Neck Ring	SUS304+NBR	
88	Nut	Stainless Steel	304
89	Bearing	NBR	

General Data



Example: SP-90

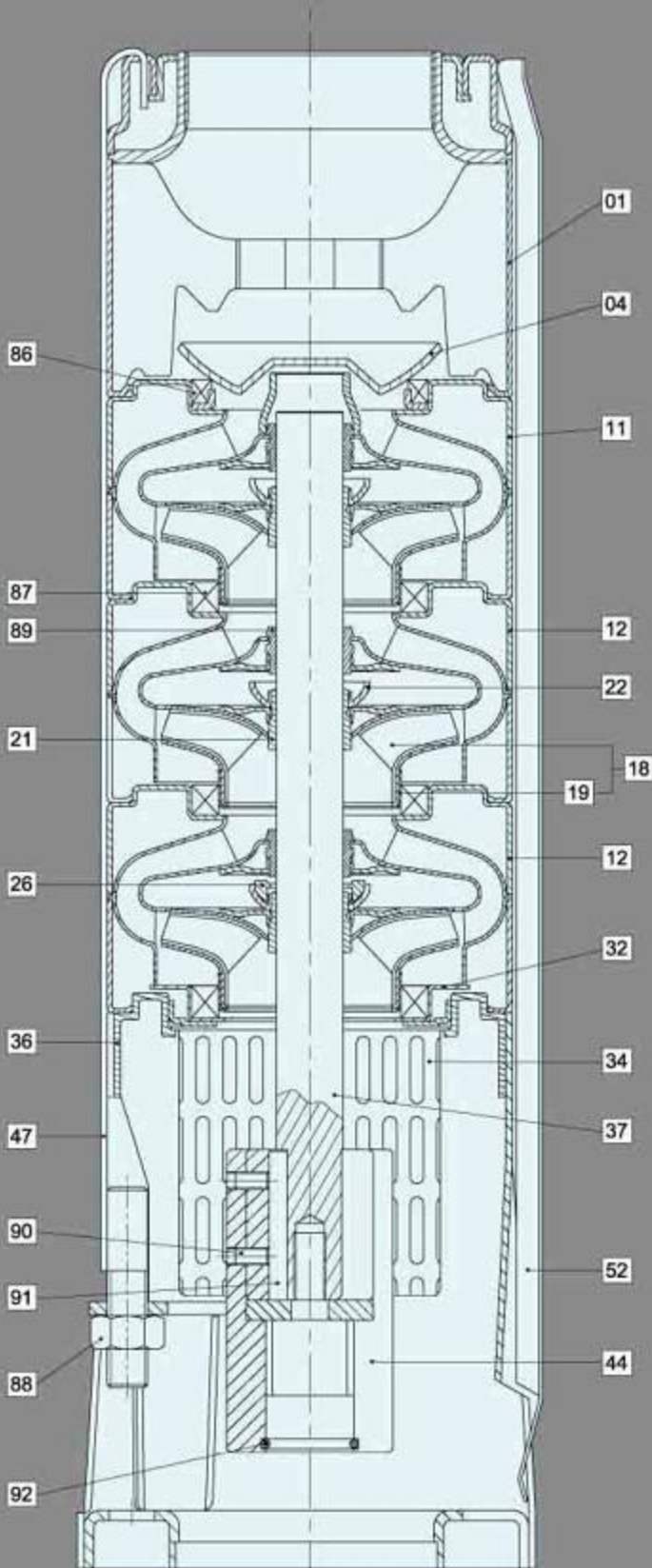

Material Specification-6" Pumps

Pos.	Components	Material	Standard
01	Discharge	Stainless Steel	304
04	Valve Cone	Stainless Steel	304
11	Top Diffuser	Stainless Steel	304
12	Diffuser	Stainless Steel	304
18	Impeller	Stainless Steel	304
19	Ring Of Impeller	Stainless Steel	304
21	Split Cone	Stainless Steel	304
22	Split Cone Nut	Stainless Steel	304
26	Spacing Washer For Stop Ring	Carbon/ Graphite/PTFE	
32	Neck Ring Retainer	Stainless Steel	304
34	Strainer	Stainless Steel	304
36	Suction Interconnector	Stainless Steel	304
37	Pump Shaft	Stainless Steel	431
44	Coupling	Stainless Steel	304
47	Strap	Stainless Steel	304
52	Cable Guard	Stainless Steel	304
86	Valve Seat	SUS304+NBR	
87	Neck Ring	SUS304+NBR	
88	Nut	Stainless Steel	304
89	Bearing	NBR	
90	Screw	Stainless Steel	304
91	Key	Stainless Steel	304
92	O-ring	NBR	

General Data



Example: SP500

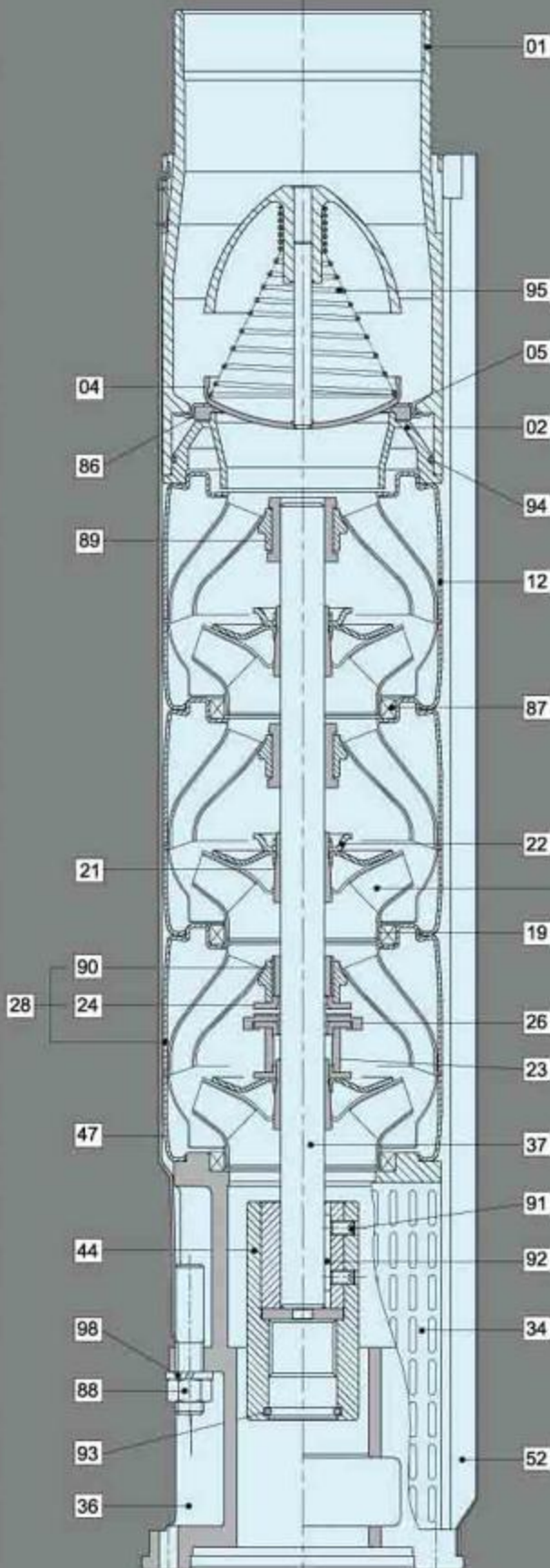

Material Specification-8" Pumps

Pos.	Components	Material	Standard
01	Discharge	Stainless Steel	304
02	Lower Valve Seat Retainer	Stainless Steel	304
04	Valve Cup	Stainless Steel	304
05	Upper Valve Seat Retainer	Stainless Steel	304
12	Diffuser	Stainless Steel	304
18	Impeller	Stainless Steel	304
19	Ring Of Impeller	Stainless Steel	304
21	Split Cone	Stainless Steel	304
22	Split Cone Nut	Stainless Steel	304
23	Nut For Stop Ring	Stainless Steel	304
24	Stop Ring	Stainless Steel	304
26	Spacing Washer For Stop Ring	Carbon/ Graphite/PTFE	
28	Bottom Diffuser	Stainless Steel	304
34	Strainer	Stainless Steel	304
36	Suction Interconnector	Stainless Steel	304
37	Pump Shaft	Stainless Steel	431
44	Coupling	Stainless Steel	304
47	Strap	Stainless Steel	304
52	Cable Guard	Stainless Steel	304
86	Valve Seat	NBR	
87	Neck Ring	SUS304+NBR	
88	Nut	Stainless Steel	304
89	Bearing	NBR	
90	Bearing	NBR+SUS304	
91	Screw	Stainless Steel	304
92	Key	Stainless Steel	304
93	O-ring	NBR	
94	O-ring	NBR	
95	Spring	Stainless Steel	304
98	Spring Washer	Stainless Steel	304

4" Stainless Steel Submersible Pumps

Stairs' SP 4" range of submersible pumps are made of corrosion and abrasion resistant stainless steel and have been developed in accordance with state-of-the-art technology. The SP 4" pumps are manufactured to the highest standards for energy efficiency, dependable performance, rugged construction, and long service life.

Capacity (m³/h) min 0.3 max 18
 Total Head: Max. 285 m

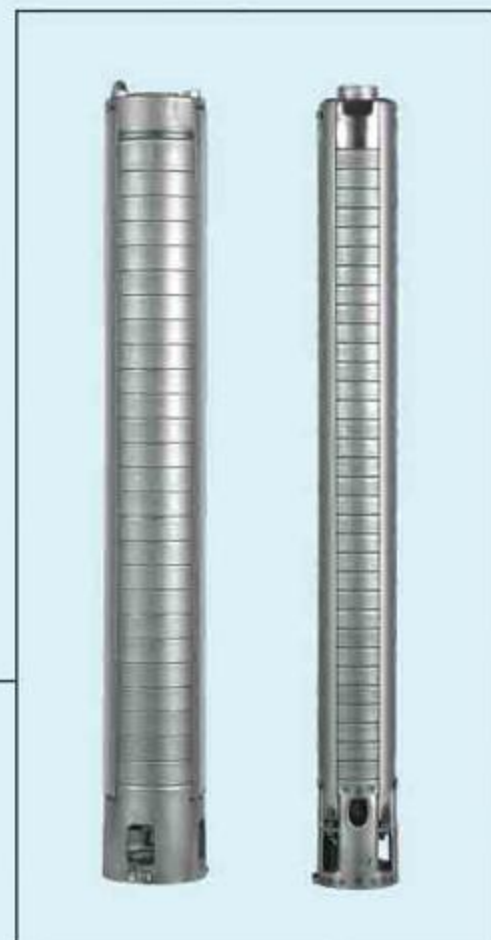

Applications

- ◆ Potable water supply from deep wells
- ◆ Agricultural-Irrigation, livestock watering, etc.
- ◆ Municipal and industrial
- ◆ Pressure boosting
- ◆ Fountains, etc.

Pumped Liquids

- ◆ Clean, non-corrosive and non-abrasive liquids.

Operating Conditions

- ◆ Max. ambient temperature (Liquid): 30°C
- ◆ Sand content: Max. 50 g/m³

Features

- ◆ Stainless steel construction designed and built for years of trouble free operation
- ◆ All metal parts are made of 304 stainless steel, except for the shaft, which is made of 431 stainless steel
- ◆ Heavy duty stainless steel discharge head with built-in check valve for long life and ease of installation
- ◆ Smooth safety hook
- ◆ Mounting specifications are according to NEMA standards
- ◆ High quality shaft bearings providing low friction and high wear resistance
- ◆ Heavy duty stainless steel impellers & diffusers ensuring optimal performance
- ◆ Stainless steel strainer to restrict the entry of sand and other extraneous material

General Data



6" Stainless Steel Submersible Pumps

Stairs' SP 6" stainless steel submersible pumps are made of high quality 304 or 316 corrosion resistant stainless steel. Shafts are made of high strength 431 stainless steel. The pumps are designed for efficient and dependable performance, and a long and trouble-free life. The pumps are light in weight and ruggedly constructed for heavy duty applications.

Capacity (m³/h) min 3 max 78
Total Head: Max. 433 m

Applications

- ◆ Potable water supply from deep wells
- ◆ Agricultural-Irrigation and livestock watering
- ◆ Municipal and industrial water supply
- ◆ Pressure boosting
- ◆ Mine de-watering
- ◆ Fountains, etc.

Pumped Liquids

- ◆ Clean, non corrosive and non-abrasive liquids.

Operating Conditions

- ◆ Max. ambient temperature (Liquid): 30°C
- ◆ Sand content: Max. 50 g/m³

Features

- ◆ Stainless steel construction designed and built for years of trouble free operation
- ◆ Heavy duty stainless steel discharge head with built-in check valve for long life and ease of installation
- ◆ Mounting specifications are according to NEMA standards
- ◆ High quality shaft bearings providing low friction and high wear resistance
- ◆ Heavy duty stainless steel impellers & diffusers ensuring optimal performance
- ◆ Stainless steel strainer to restrict the entry of sand and other extraneous material



8" Stainless Steel Submersible Pumps

Stairs' SP 8" submersible pumps are designed for heavy duty and high volume pumping applications. Highly efficient hydraulic impeller and diffuser designs reduce energy requirements and provide long and dependable service life, even in difficult environments.

Capacity (m³/h) min 12 max 120

Total Head: Max. 412 m

Applications

- ◆ Municipal water supply and distribution
- ◆ Municipal water treatment
- ◆ Industrial-for cooling, cleaning and production
- ◆ Agriculture-for irrigation, etc.
- ◆ Pressure boosting in high rise buildings, etc.
- ◆ Dewatering in mines
- ◆ Fountains, etc.

Pumped Liquids

- ◆ Clean, non corrosive and non-abrasive liquids.

Operating Conditions

- ◆ Max. ambient temperature (Liquid): 30°C
- ◆ Sand content: Max. 50 g/m³

Features

- ◆ High pump efficiency means lower energy consumption and thus lower operating costs
- ◆ Designed and built to operate under difficult conditions
- ◆ High quality materials and high quality workmanship assures high quality pumps
- ◆ All metal parts are made of 304 stainless steel, except for the shafts, which are made of 431 stainless steel
- ◆ 431 stainless steel pump shafts assure strength with resistance to mechanical wear and corrosion
- ◆ Heavy duty stainless steel discharge head with built-in check valve for long life and ease of installation
- ◆ A high strength stainless steel coupling facilitates a proper pump/motor alignment
- ◆ Mounting specifications are according to NEMA standards



Stairs SP Series



SP 4"

SP05 Performance Curves

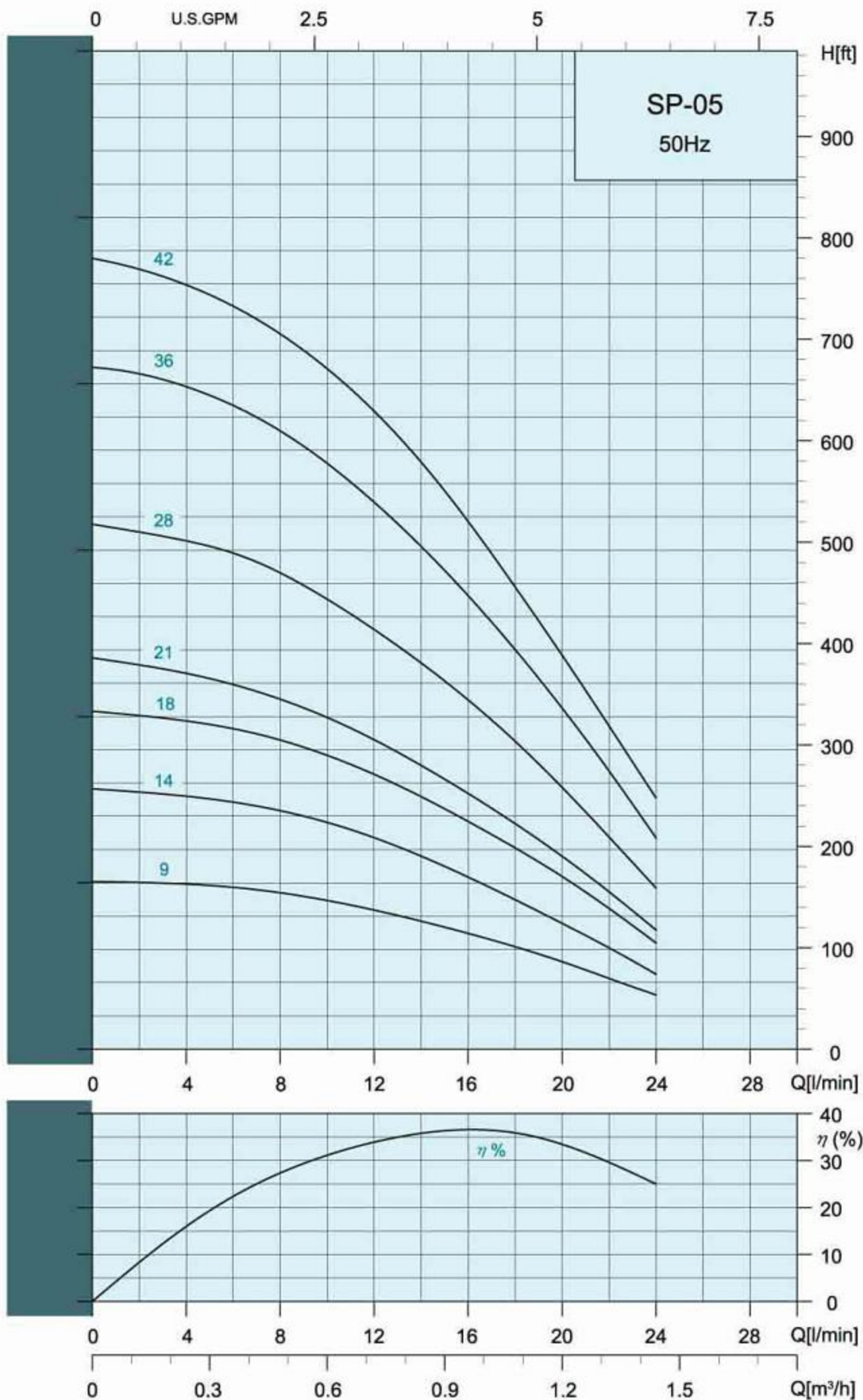

Technical Data

Selection Chart

Pump Type	STAGES	KW	HP	Q=DELIVERY																	
				l/min	0	5	10	15	20	25	30	35	40	45	50	60	70	80	90	100	120
				m ³ /h	0	0.3	0.6	0.9	1.2	1.5	1.8	2.1	2.4	2.7	3.0	3.6	4.2	4.8	5.4	6.0	7.2
				H =TOTAL HEAD IN METERS																	
SP-0509	9	0.37	0.5	52	48	45	36	27	14												
SP-0514	14	0.37	0.5	79	76	68	56	38	21												
SP-0518	18	0.55	0.75	102	96	88	72	52	27												
SP-0521	21	0.55	0.75	118	112	100	81	58	30												
SP-0528	28	0.75	1.0	158	153	138	111	78	42												
SP-0536	36	1.1	1.5	205	195	175	134	103	54												
SP-0542	42	1.1	1.5	238	235	203	167	118	67												

Dimensions And Weights

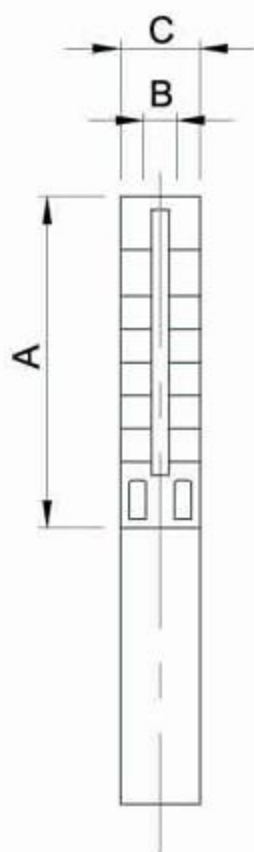

Pump Type	Dimensions(mm)			Net Weight(Kg)
	A	B	C	Pump
SP-0509	356	RP/NPT 1 1/4"	98	2.9
SP-0514	461		98	3.7
SP-0518	545		98	4.4
SP-0521	608		98	5.0
SP-0528	755		98	6.2
SP-0536	946		98	9.9
SP-0542	1072		98	11.3

C = Maximum diameter of pump inclusive of cable guard and motor

Stairs SP Series



STAIRS PUMPS

SP 4"

SP10 Performance Curves

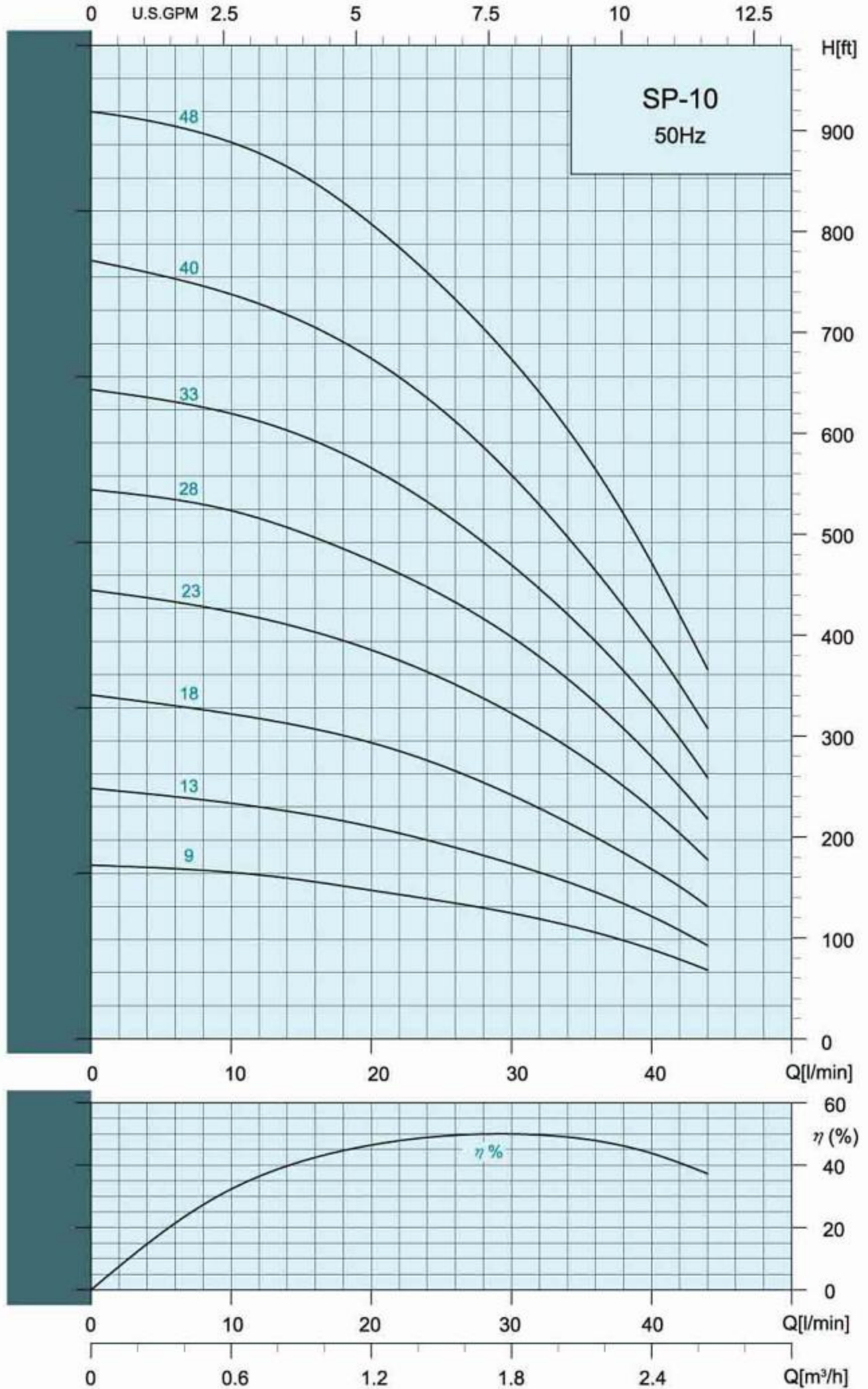

Selection Chart

Pump Type	STAGES	KW	HP	Q=DELIVERY																
				l/min	0	5	10	15	20	25	30	35	40	45	50	60	70	80	90	100
				m ³ /h	0	0.3	0.6	0.9	1.2	1.5	1.8	2.1	2.4	2.7	3.0	3.6	4.2	4.8	5.4	6.0
				H =TOTAL HEAD IN METERS																
SP-1009	9	0.37	0.5	53			48	45	42	38	33	26								
SP-1013	13	0.55	0.75	77			68	64	58	54	46	38								
SP-1018	18	0.75	1.0	104			94	89	83	74	64	51								
SP-1023	23	1.1	1.5	136			124	118	108	98	84	69								
SP-1028	28	1.5	2.0	166			154	145	134	122	105	86								
SP-1033	33	1.5	2.0	195			183	173	159	143	124	102								
SP-1040	40	2.2	3.0	235			218	205	190	170	147	119								
SP-1048	48	2.2	3.0	280			261	246	228	204	178	143								

Dimensions And Weights

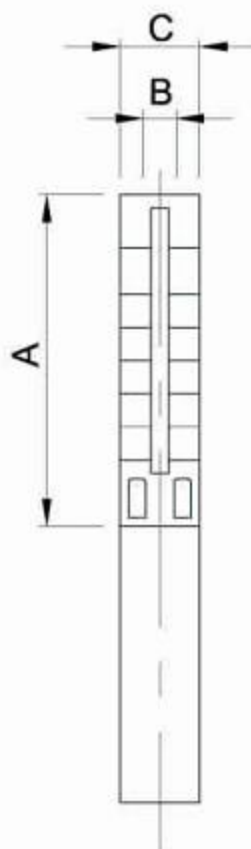

Pump Type	Dimensions(mm)			Net Weight(Kg)
	A	B	C	Pump
SP-1009	356	RP/NPT 1 1/4"	98	3.0
SP-1013	440		98	3.8
SP-1018	545		98	4.7
SP-1023	650		98	5.7
SP-1028	755		98	6.6
SP-1033	883		98	9.7
SP-1040	1030		98	11.5
SP-1048	1198		98	13.5

C = Maximum diameter of pump inclusive of cable guard and motor

Stairs SP Series



STAIRS PUMPS

SP 4"

SP18 Performance Curves

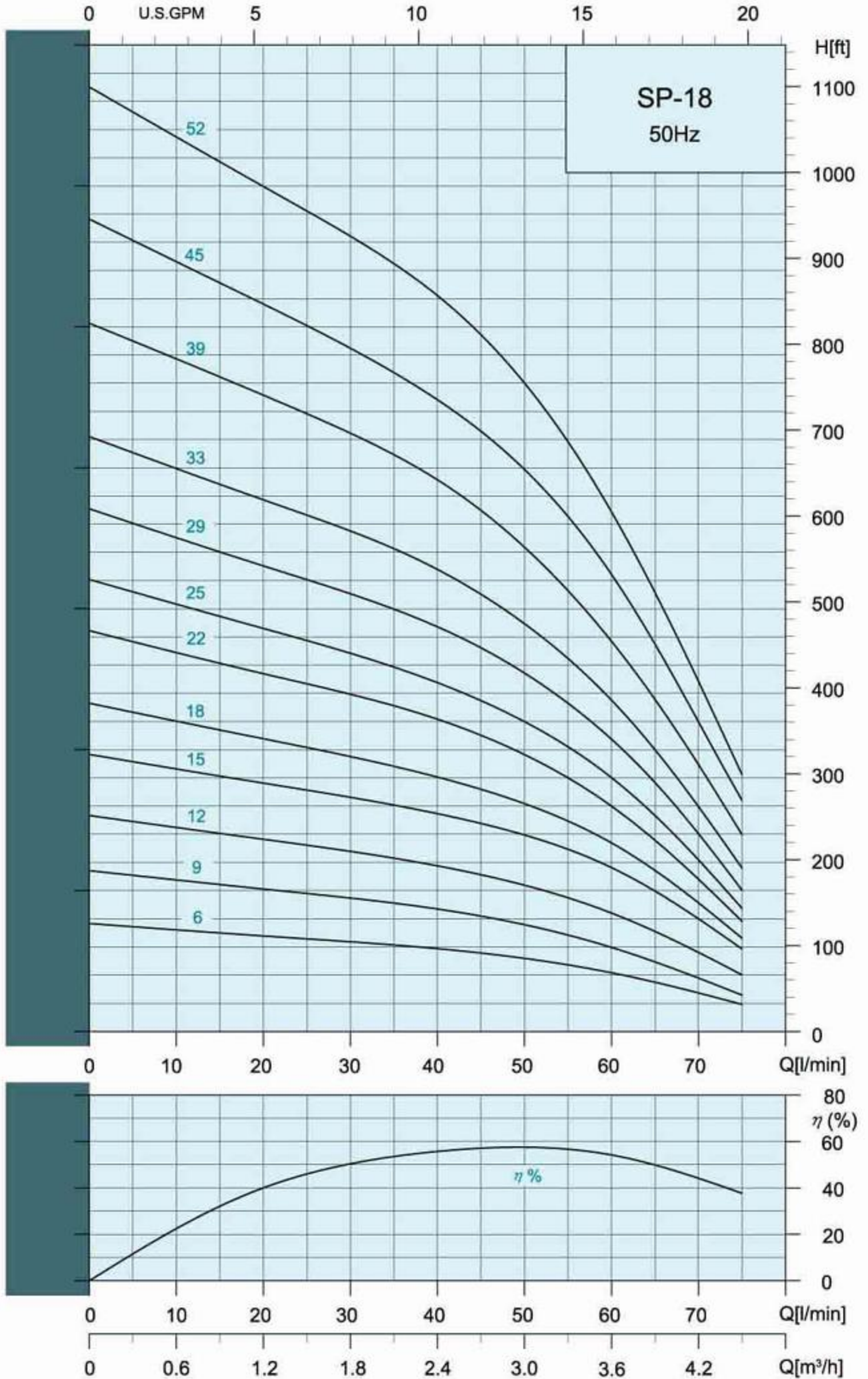

Stairs SP Series



SP 4"

SP25 Performance Curves

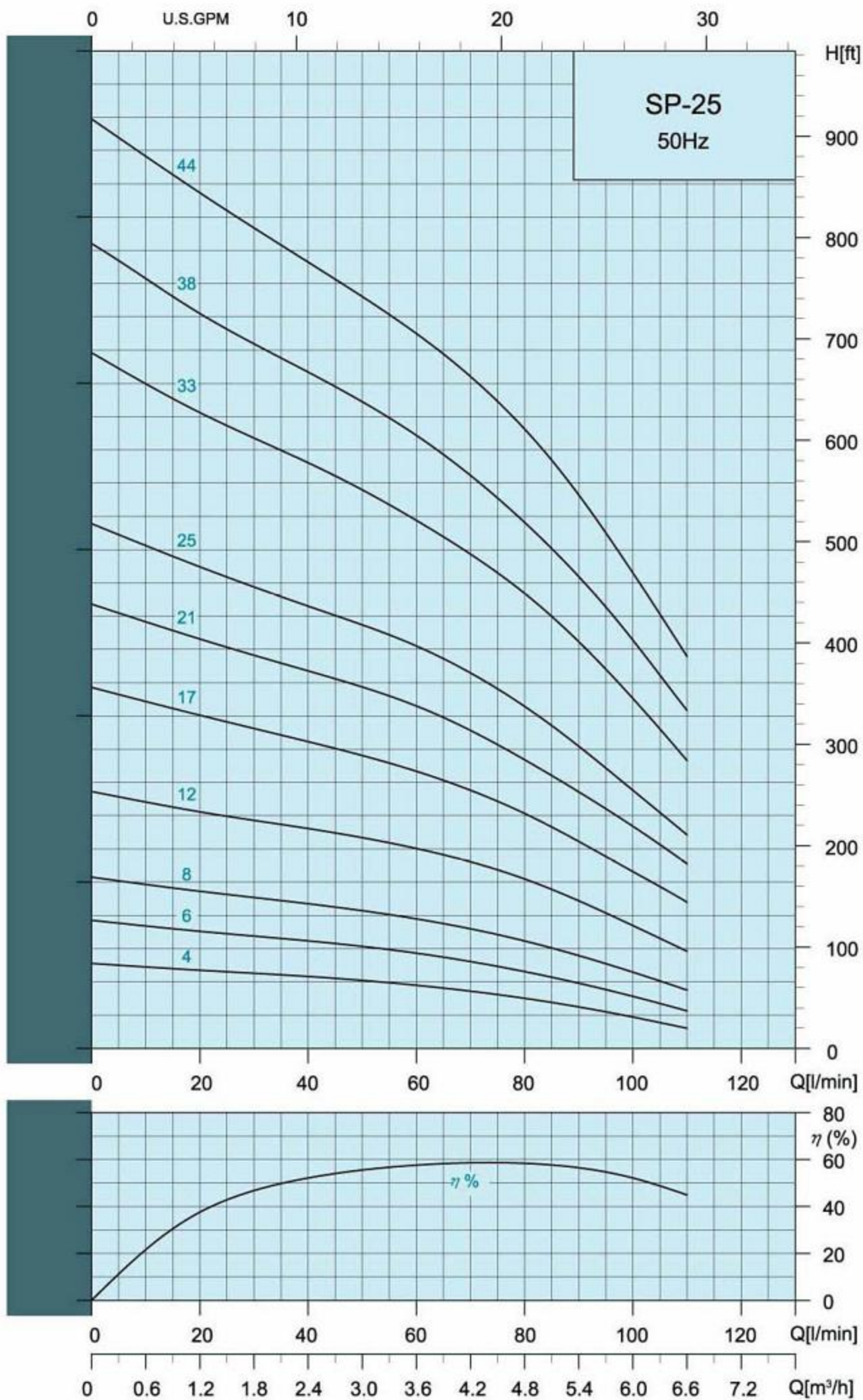

Selection Chart

Pump Type	STAGES	KW	HP	Q=DELIVERY																
				l/min	15	20	25	30	35	40	45	50	60	70	80	90	100	120	140	160
				m ³ /h	0.9	1.2	1.5	1.8	2.1	2.4	2.7	3.0	3.6	4.2	4.8	5.4	6.0	7.2	8.4	9.6
				H =TOTAL HEAD IN METERS																
SP-2504	4	0.37	0.5	25				23	22	21	20.5	20	19	17	15	13	10			
SP-2506	6	0.55	0.75	38				34	33	32	31	30	28	26	24	20	16			
SP-2508	8	0.75	1.0	52				45	44	43	42	41	39	36	33	28	23			
SP-2512	12	1.1	1.5	77				68	67	66	64	63	60	56	50	44	37			
SP-2517	17	1.5	2.0	108				96	94	93	90	88	84	77	70	63	54			
SP-2521	21	2.2	3.0	134				118	115	113	111	108	103	96	87	77	67			
SP-2525	25	2.2	3.0	157				138	136	133	129	127	121	113	103	90	78			
SP-2533	33	3.0	4.0	209				184	180	176	172	168	159	149	137	123	105			
SP-2538	38	4.0	5.5	242				212	208	204	199	194	185	172	158	142	123			
SP-2544	44	4.0	5.5	279				247	242	237	231	226	215	202	187	166	143			

Dimensions And Weights

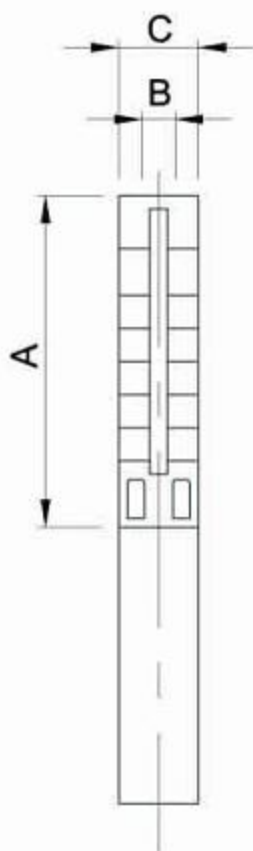

Pump Type	Dimensions(mm)			Net Weight(Kg)
	A	B	C	Pump
SP-2504	251	RP/NPT 1 1/2"	98	2.0
SP-2506	293		98	2.4
SP-2508	335		98	2.8
SP-2512	419		98	3.6
SP-2517	524		98	4.5
SP-2521	608		98	5.3
SP-2525	692		98	6.0
SP-2533	868		98	9.6
SP-2538	973		98	10.9
SP-2544	1099		98	12.4

C = Maximum diameter of pump inclusive of cable guard and motor

Stairs SP Series



SP 4"

SP40 Performance Curves

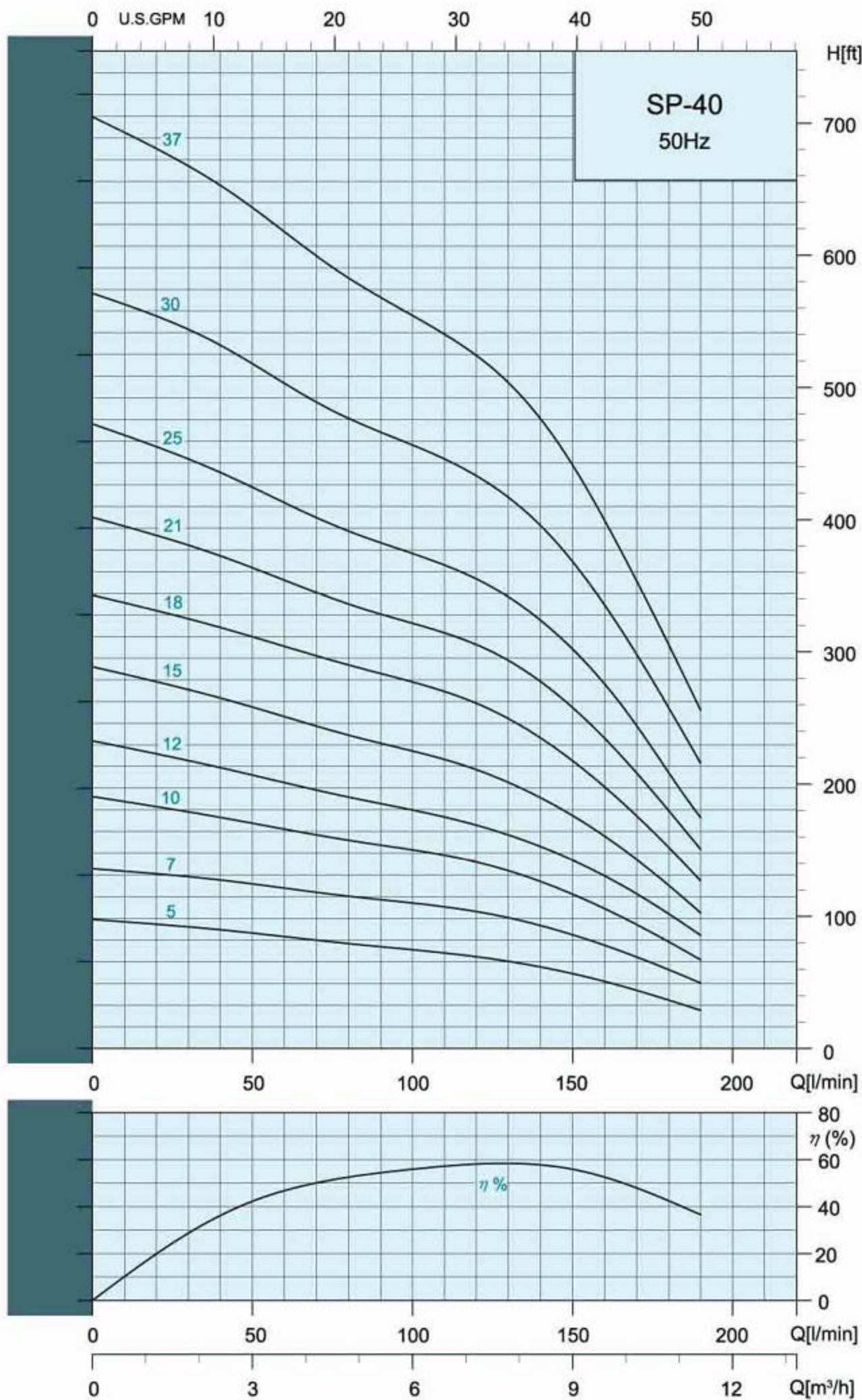

Selection Chart

Pump Type	STAGES	KW	HP	Q=DELIVERY																	
				l/min	30	35	40	45	50	60	70	80	90	100	120	140	160	180	200	250	300
				m ³ /h	0	1.8	2.1	2.4	2.7	3.0	3.6	4.2	4.8	5.4	6.0	7.2	8.4	9.6	10.8	12	15
H = TOTAL HEAD IN METERS																					
SP-4005	5	0.75	1.0	30			28	27	26	26	25	24	23	22	21	19	15	12			
SP-4007	7	1.1	1.5	41			38	37	36	36	35	35	34	34	32	27	24	17			
SP-4010	10	1.5	2.0	58			54	53	52	51	49	47	47	46	43	38	32	25			
SP-4012	12	2.2	3.0	71			65	64	63	61	60	58	57	55	52	47	40	31			
SP-4015	15	2.2	3.0	87			80	79	78	76	74	72	70	68	64	57	49	38			
SP-4018	18	3.0	4.0	104			98	96	95	93	90	88	86	84	79	72	60	47			
SP-4021	21	4.0	5.5	122			114	113	111	107	105	102	100	98	93	85	72	55			
SP-4025	25	4.0	5.5	144			133	131	128	126	123	119	116	114	107	97	84	64			
SP-4030	30	5.5	7.5	174			163	160	157	154	149	145	142	139	131	120	103	79			
SP-4037	37	5.5	7.5	215			199	196	194	188	183	177	173	169	160	145	122	93			

Dimensions And Weights

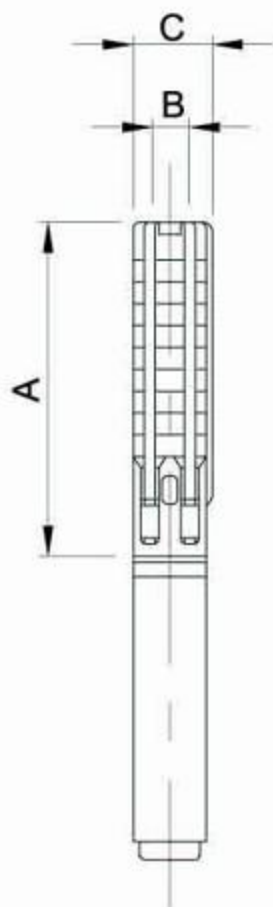

Pump Type	Dimensions(mm)			Net Weight(Kg)
	A	B	C	Pump
SP-4005	412	RP/NPT 2"	98	4.3
SP-4007	496		98	5.3
SP-4010	622		98	6.8
SP-4012	706		98	7.8
SP-4015	832		98	9.3
SP-4018	958		98	10.8
SP-4021	1084		98	12.3
SP-4025	1252		98	14.3
SP-4030	1462		98	16.8
SP-4037	1753		98	20.3

C = Maximum diameter of pump inclusive of cable guard and motor

Stairs SP Series



SP 4"

SP70 Performance Curves

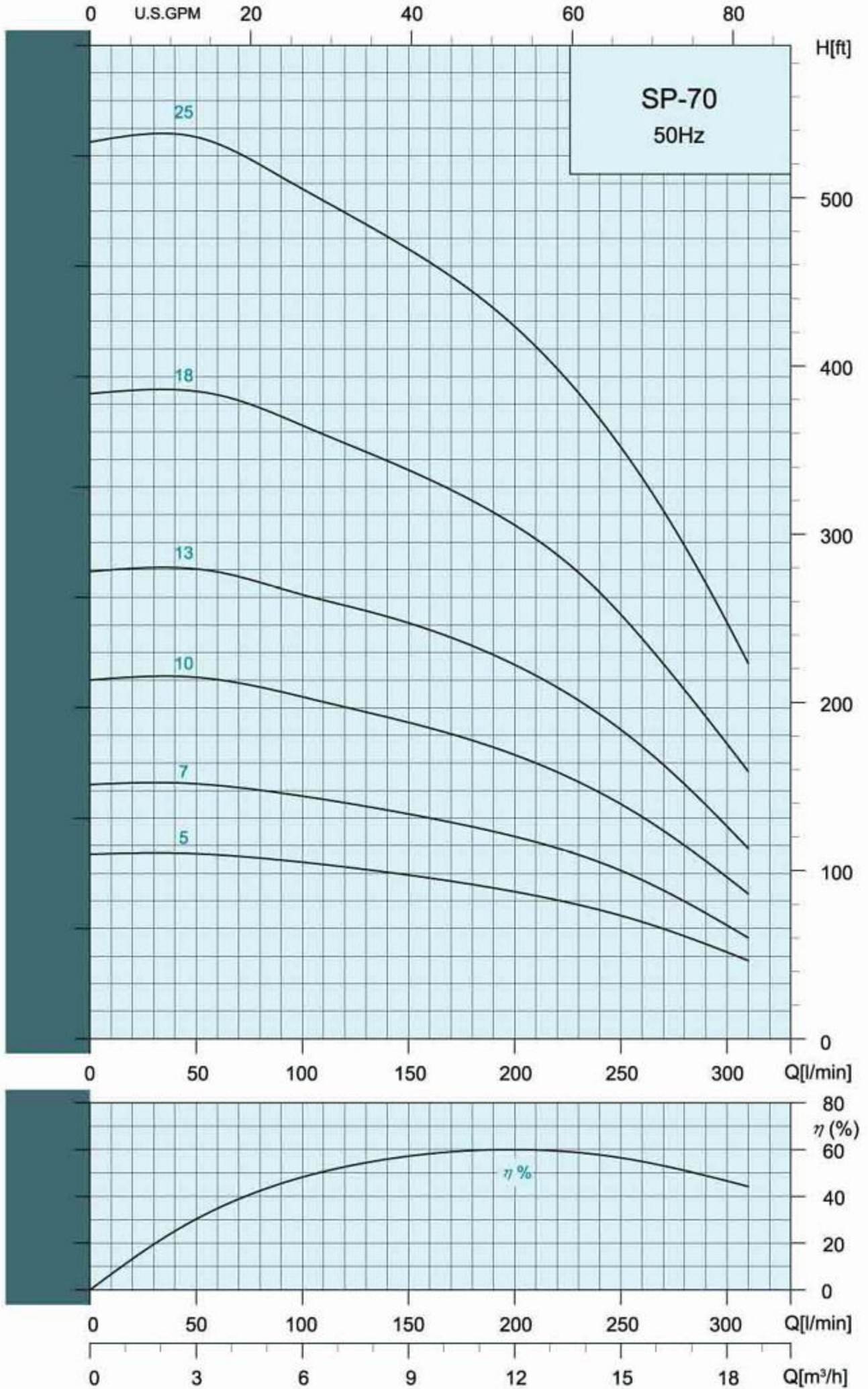

Selection Chart

Pump Type	STAGES	KW	HP	Q=DELIVERY															
				l/min	70	80	90	100	120	140	160	180	200	250	300	320	340	360	380
				m ³ /h	4.2	4.8	5.4	6.0	7.2	8.4	9.6	10.8	12	15	18	19	20	22	23
				H =TOTAL HEAD IN METERS															
SP-7005	5	1.5	2.0	33				32	31	30	28	27	26	22	16				
SP-7007	7	2.2	3.0	46				44	43	42	40	37	36	30	20				
SP-7010	10	3.0	4.0	65				62	60	58	57	54	52	43	29				
SP-7013	13	4.0	5.5	84				80	78	77	74	72	67	56	38				
SP-7018	18	5.5	7.5	117				111	108	104	102	97	93	77	54				
SP-7025	25	7.5	10	163				154	149	145	141	135	129	107	75				

Dimensions And Weights

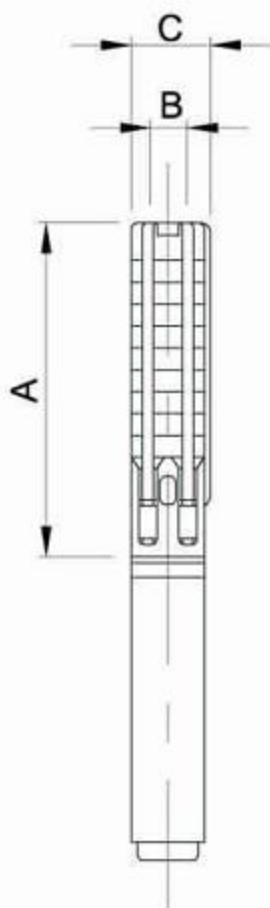

Pump Type	Dimensions(mm)			Net Weight(Kg)
	A	B	C	Pump
SP-7005	505	RP/NPT 2"	98	5.0
SP-7007	635		98	6.3
SP-7010	830		98	8.2
SP-7013	1025		98	10.2
SP-7018	1350		98	13.4
SP-7025	1805		98	17.8

C = Maximum diameter of pump inclusive of cable guard and motor

Stairs SP Series



SP 6"

SP90 Performance Curves

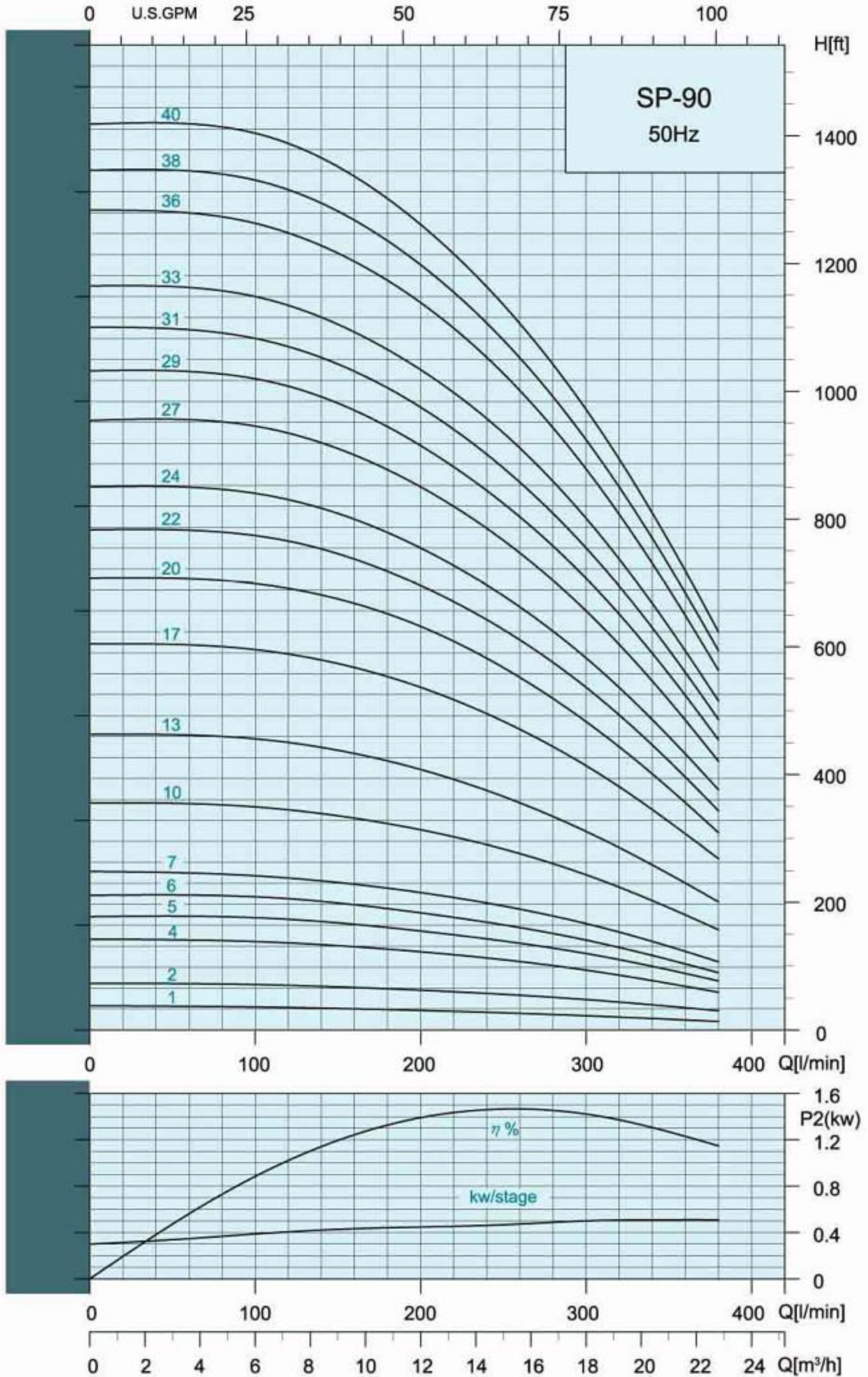

Selection Chart

Pump Type	Motor		Max.current		m ³ /h l/min	Q capacity 2900 rpm							
	P2		Amp			3	6	9	12	15	18	21	23
	KW	HP	220V	380V		50	100	150	200	250	300	350	383
SP 90-1	0.55	0.75	2.6	1.5	100	11.5	11	10.5	9.5	8	7	6	4
SP 90-2	1.1	1.5	5.2	3.0		22	21.5	20	19	17.5	14	12	9
SP 90-4	2.2	3	9.5	5.5		42.5	42	40	38	33	28.5	23	18
SP 90-5	3	4	13.3	7.7		53	52	50.5	47.5	42.5	37	28.5	22
SP 90-6	3.7	5	15.4	8.9		64	63	60	56	50	43	34	27
SP 90-7	4	5.5	17	10.4		75	74	70	66	59	50.5	40	32
SP 90-10	5.5	7.5	22.2	12.8		108	107	102	95	86	74	60	48

Pump Type	13	17.5	50	29	SPS	260	257	247	230	208	178	140	115
SP 90-24	13	17.5	50	29		260	257	247	230	208	178	140	115
SP 90-27	15	20	55	32		291	288	277	259	234	200	158	128
SP 90-29	18.5	25	69	40		314	311	300	279	250	215	170	138
SP 90-31	18.5	25	69	40		335	330	318	298	269	230	181	148
SP 90-33	18.5	25	69	40		355	350	337	315	285	243	191	157
SP 90-36	22	30	81	47		390	385	371	348	313	268	210	170
SP 90-38	22	30	81	47		410	405	390	365	330	281	222	180
SP 90-40	22	30	81	47		433	428	412	384	346	296	235	190



Dimensions And Weights

Pump Type	Dimensions(mm)				Net Weight(Kg) Pump
	A	B	C*	C**	
SP 90-1	343		131		5
SP 90-2	403		131		6.4
SP 90-4	524		131		9.3
SP 90-5	585		131		10.8
SP 90-6	645		131		12.2
SP 90-7	706		131		13.7
SP 90-10	887		131		18
SP 90-13	1069		142	142	22.4
SP 90-17	1311	RP	142	142	28.2
SP 90-20	1492	2 1/2"	142	142	32.5
SP 90-22	1613	NPT	142	142	35.4
SP 90-24	1734	3"	142	142	38.3
SP 90-27	1916		142	142	42.7
SP 90-29	2037		142	142	45.6
SP 90-31	2158		142	142	48.5
SP 90-33	2279		142	142	51.4
SP 90-36	2460		142	142	55.7
SP 90-38	2581		142	142	58.6
SP 90-40	2702		142	142	61.5

C*: Maximum diameter of pump with one motor cable

C**: Maximum diameter of pump with two motor cable

Stairs SP Series



STAIRS PUMPS

SP 6"

SP150 Performance Curves

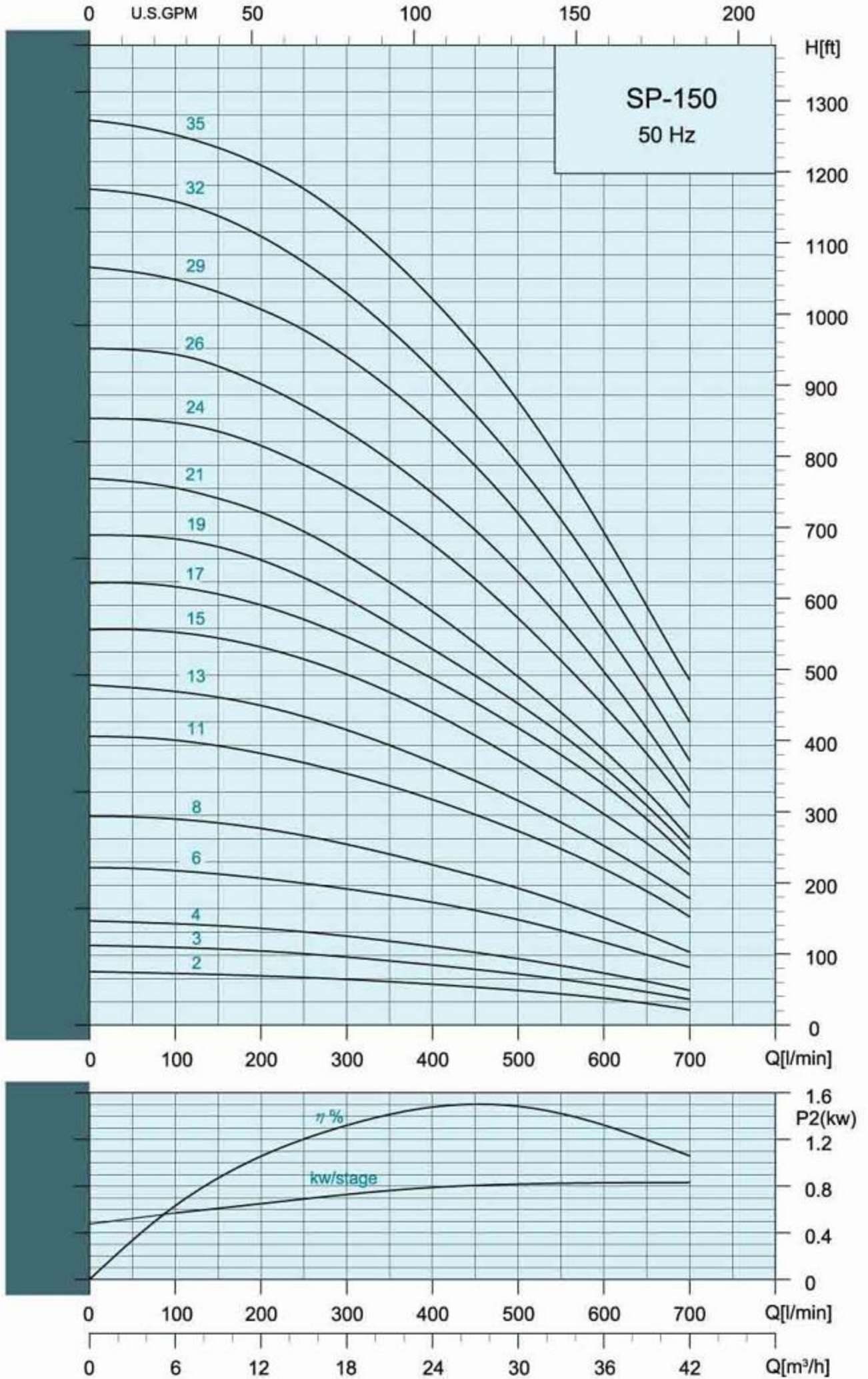

Selection Chart

Pump Type	Motor		Max.current		m ³ /h l/min	Q capacity 2900 rpm												
	P2		Amp			6	9	12	15	18	21	24	27	30	33	36	39	42
	KW	HP	220V	380V		100	150	200	250	300	350	400	450	500	550	600	650	700
SP150-2	2.2	3	9.5	5.5	HEAD IN METERS	23	22	21	20	19	18	17	16	15	13	11	9	6
SP150-3	3	4	13.3	7.7		33	32	31	30	29	28	26	24	22	20	17	14	11
SP150-4	3.7	5	15.4	8.9		43	42	41	40	38	36	34	31	28	26	23	19	15
SP150-6	5.5	7.5	22.2	12.8		67	64	62	60	58	56	52	49	45	40	36	30	25
SP150-8	7.5	10	28.5	16.5		88	87	84	81	78	73	68	64	58	53	46	38	31
SP150-11	11	15	41.8	24.2		122	120	117	112	108	102	97	90	83	76	67	57	47
SP150-13	11	15	41.8	24.2		143	140	137	132	127	120	113	105	97	87	77	66	55
SP150-15	15	20	55	32		168	166	162	157	150	142	134	124	113	102	90	77	65
SP150-17	15	20	55	32		188	185	180	173	167	158	148	138	127	116	103	88	71
SP150-19	18.5	25	69	40		208	205	199	192	182	172	161	150	137	125	110	94	77
SP150-21	18.5	25	69	40		230	226	220	212	202	190	177	164	149	134	117	100	80
SP150-24	22	30	81	47		258	254	248	240	230	219	207	191	175	156	137	117	93
SP150-26	22	30	81	47		287	282	275	266	255	242	227	212	194	173	152	127	100
SP150-29	26	35	96	56		319	314	307	298	287	273	257	240	220	196	170	143	113
SP150-32	30	40	111	64		353	347	338	327	313	298	281	261	240	217	190	160	130
SP150-35	30	40	111	64		382	377	368	358	346	329	311	290	267	240	211	180	148

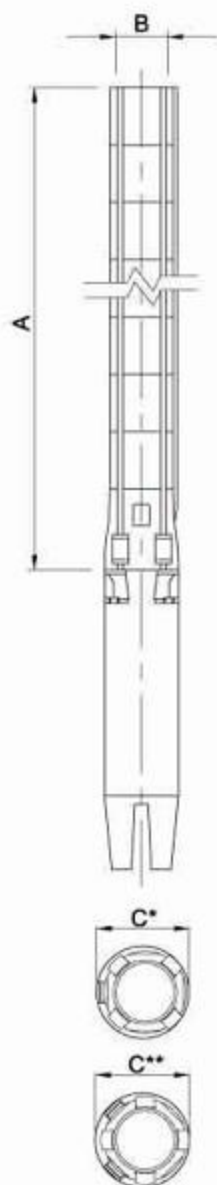

Dimensions And Weights

Pump Type	Dimensions(mm)				Net Weight(Kg)
	A	B	C*	C**	Pump
SP150-2	462	NPT/ RP 3"	131		8.4
SP150-3	558		131		10.1
SP150-4	654		131		11.8
SP150-6	846		131		15.2
SP150-8	1038		142	142	18.6
SP150-11	1326		142	142	23.6
SP150-13	1518		142	142	27
SP150-15	1710		142	142	30.4
SP150-17	1902		142	142	33.8
SP150-19	2094		142	142	37.2
SP150-21	2286		142	142	40.6
SP150-24	2574		142	142	45.6
SP150-26	2766		142	142	49
SP150-29	3054		142	142	54.1
SP150-32	3342		142	142	59.2
SP150-35	3630		142	142	64.3

C*: Maximum diameter of pump with one motor cable

C**: Maximum diameter of pump with two motor cable

Stairs SP Series



STAIRS PUMPS

SP 6"

SP230 Performance Curves

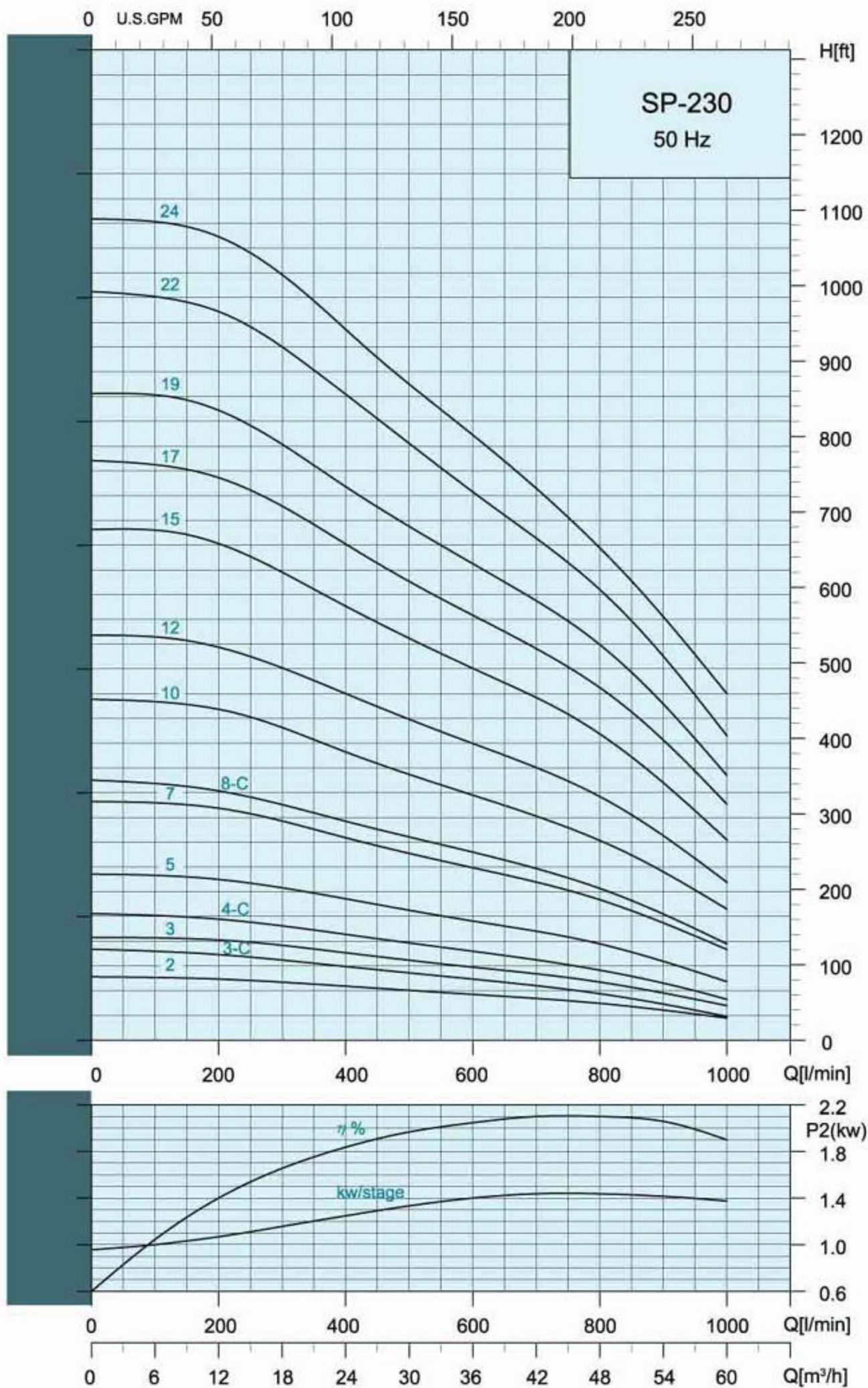

Selection Chart

Pump Type	Motor		Max.current		m ³ /h l/min	Q capacity 2900 rpm											
	P2		Amp			12	15	18	21	24	27	30	36	42	48	54	60
	KW	HP	220V	380V		200	250	300	350	400	450	500	600	700	800	900	1000
SP230-2	3	4	13.3	7.7	HEAD IN METERS	24	23.5	23	22.5	22	21	20	18	17	15	12	9
SP230-3C	3.7	5	15.4	8.9		35	34	32	31	29	28	27	24	22	19	14	10
SP230-3	5.5	7.5	22.2	12.8		40	39	38	37	35	34	33	29	27	23	18	14
SP230-4C	5.5	7.5	22.2	12.8		49	47	46	45	43	41	39	36	32	28	23	17
SP230-5	7.5	10	28.5	16.5		65	63	61	59	57	55	53	48	44	39	32	24
SP230-7	11	15	41.8	24.2		94	92	88	85	82	79	76	70	64	57	47	37
SP230-8C	11	15	41.8	24.2		100	98	95	92	88	85	82	76	69	61	51	39
SP230-10	15	20	55	32		133	130	127	122	117	112	107	98	90	80	67	53
SP230-12	18.5	25	69	40		158	155	150	145	140	135	130	120	110	98	83	64
SP230-15	22	30	81	47		200	195	189	183	176	169	163	150	138	124	103	81
SP230-17	26	35	96	56		227	222	215	208	200	193	186	172	158	143	121	96
SP230-19	30	40	111	64		254	248	241	233	224	216	208	193	178	160	136	107
SP230-22	37	50	138	80		294	288	280	270	260	251	241	222	203	183	155	123
SP230-24	37	50	138	80		325	317	309	298	287	276	265	244	223	199	171	140

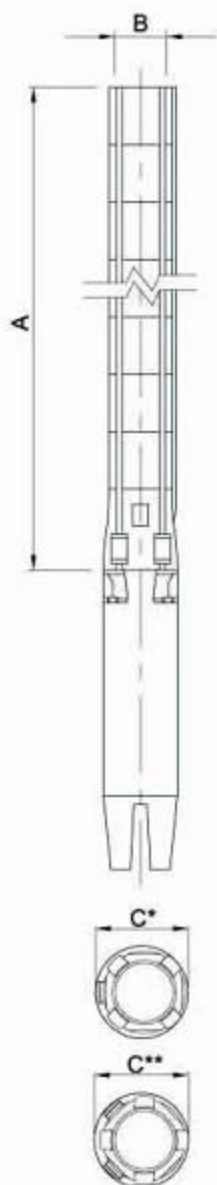

Dimensions And Weights

Pump Type	Dimensions(mm)				Net Weight(Kg) Pump
	A	B	C*	C**	
SP230-2	496	NPT/RP 3" or 4"	146		9.2
SP230-3-C	609		146		11.5
SP230-3	609		146		11.5
SP230-4-C	722		146		13.8
SP230-5	835		149	152	16
SP230-7	1061		149	152	20.6
SP230-8-C	1174		149	152	22.9
SP230-10	1400		149	152	27.4
SP230-12	1626		149	152	32
SP230-15	1965		149	152	38.8
SP230-17	2191		149	152	43.4
SP230-19	2417		149	152	47.9
SP230-22	2756		149	152	54.8
SP230-24	2982		149	152	59.3

C*: Maximum diameter of pump with one motor cable

C**: Maximum diameter of pump with two motor cable

Stairs SP Series



SP 6"

SP300 Performance Curves

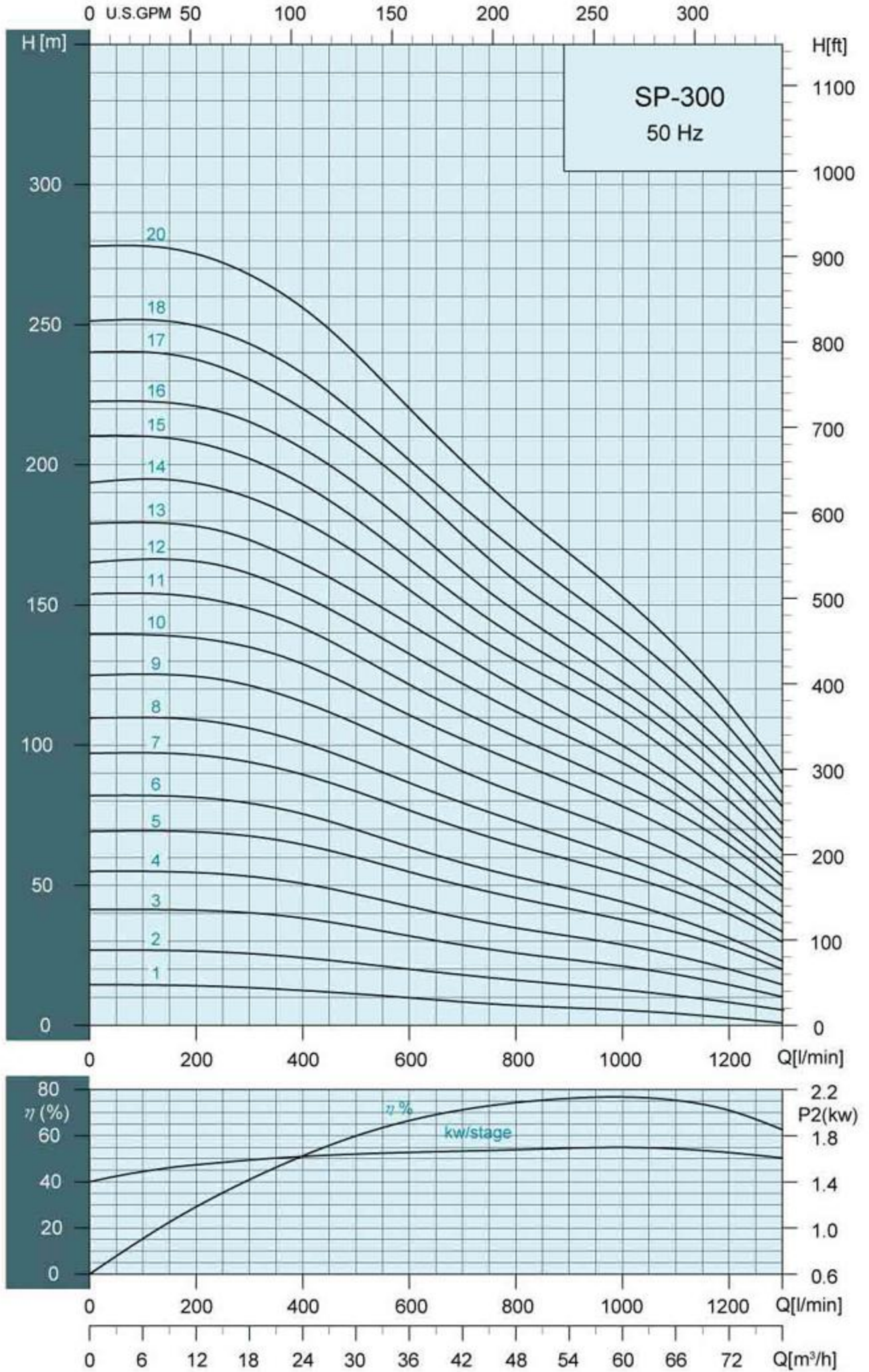

Selection Chart

Pump Type	Motor		Max. current		Q capacity 2900 rpm													
	P2		Amp		m ³ /h l/min	18	21	24	27	30	36	42	48	54	60	66	72	78
	KW	HP	220V	380V		300	350	400	450	500	600	700	800	900	1000	1100	1200	1300
SP300-1	2.2	3	9.5	5.5	HEAD IN METERS	13	12.5	12	11.5	11	10	8	7	6	5	4	2	1
SP300-2	4	5.5	15.4	8.9		26	25	24	23	22	20	18	16	14	13	11	8	5
SP300-3	5.5	7.5	22.2	12.8		40	39	38	37	36	32	28	26	24	21	18	14	10
SP300-4	7.5	10	28.5	16.5		53	52	51	48	47	43	38	35	32	28	25	20	14
SP300-5	9.3	12.5	36	20.9		67	66	64	62	60	55	50	46	42	38	33	27	19
SP300-6	11	15	41.8	24.2		79	78	76	73	70	64	58	53	48	44	38	32	23
SP300-7	13	17.5	50	29		94	92	89	86	84	77	70	64	59	54	47	40	29
SP300-8	15	20	55	32		106	104	101	97	94	87	80	73	67	60	53	44	33
SP300-9	18.5	25	69	40		122	118	116	112	108	99	91	83	76	69	61	51	38
SP300-10	18.5	25	69	40		135	132	128	125	120	111	102	95	87	78	68	57	45
SP300-11	22	30	81	47		148	146	142	137	132	122	112	103	95	86	76	64	49
SP300-12	22	30	81	47		162	157	153	148	143	133	122	112	103	94	83	68	53
SP300-13	26	35	96	56		173	169	165	160	155	143	132	121	110	100	87	73	57
SP300-14	26	35	96	56		188	184	180	175	168	156	142	130	120	109	96	80	63
SP300-15	26	35	96	56		203	197	193	187	180	166	152	138	127	116	103	86	67
SP300-16	30	40	111	64		216	211	206	200	193	178	162	148	135	123	108	92	72
SP300-17	37	50	138	80		230	226	220	214	207	192	175	158	145	132	116	97	78
SP300-18	37	50	138	80		243	238	233	226	218	202	185	170	155	141	126	107	83
SP300-20	37	50	138	80		267	263	256	248	239	220	201	184	168	153	136	115	90

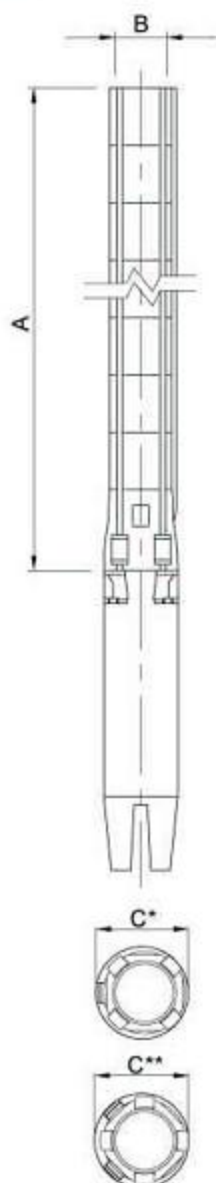

Dimensions And Weights

Pump Type	Dimensions(mm)				Net Weight(Kg)
	A	B	C*	C**	
SP300-1	383	NPT/RP 3" or 4"	146		6.9
SP300-2	496		146		9.2
SP300-3	609		146		11.5
SP300-4	722		149	152	13.7
SP300-5	835		149	152	16
SP300-6	948		149	152	18.3
SP300-7	1061		149	152	20.6
SP300-8	1174		149	152	22.9
SP300-9	1287		149	152	25.1
SP300-10	1400		149	152	27.4
SP300-11	1513		149	152	29.7
SP300-12	1626		149	152	32
SP300-13	1739		149	152	34.3
SP300-14	1852		149	152	36.5
SP300-15	1965		149	152	38.8
SP300-16	2078		149	152	41.1
SP300-17	2191		149	152	43.4
SP300-18	2304		149	152	45.7
SP300-20	2530		149	152	50.2

C*: Maximum diameter of pump with one motor cable

C**: Maximum diameter of pump with two motor cable

Stairs SP Series



STAIRS PUMPS

SP 8"

SP400 Performance Curves

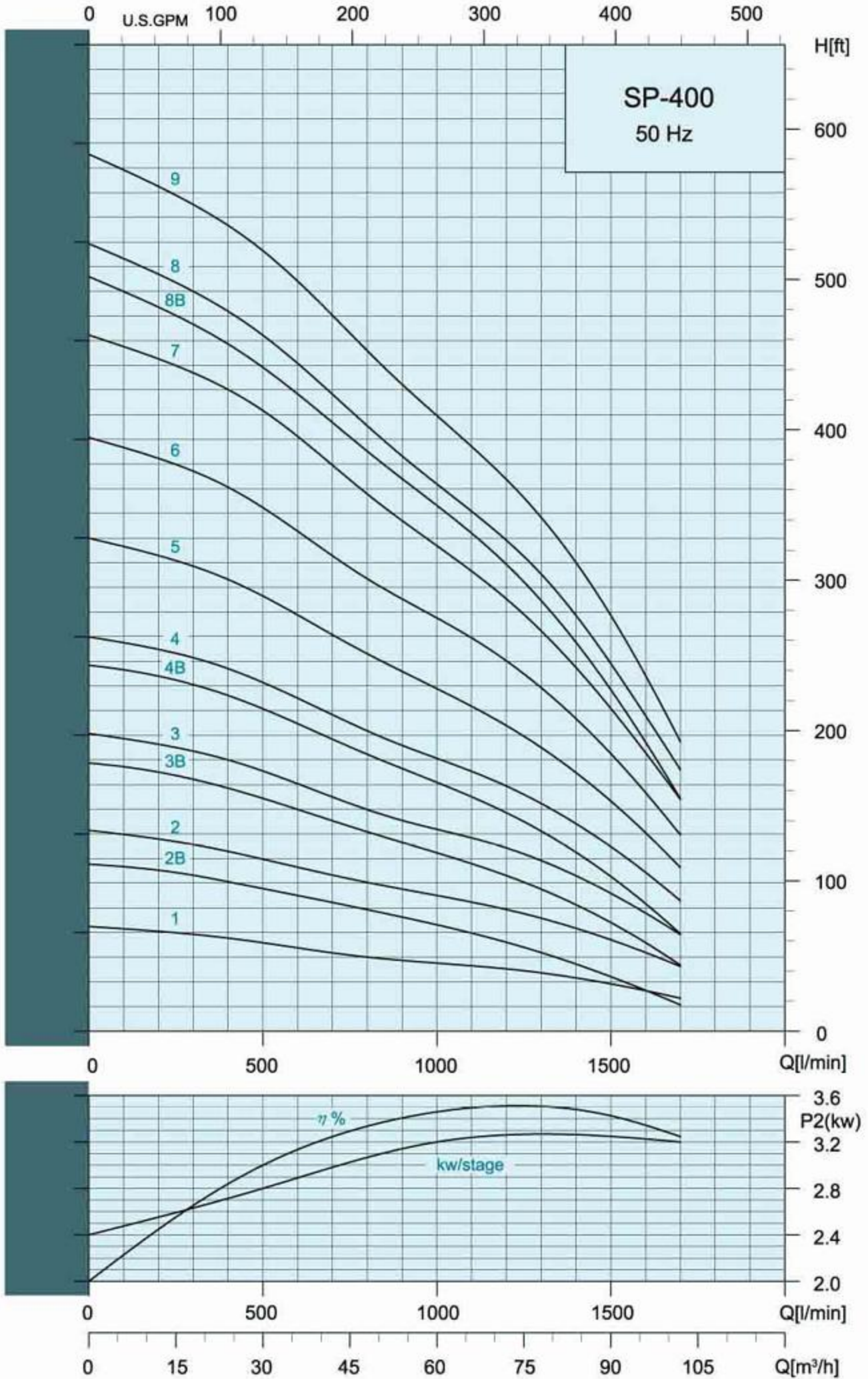

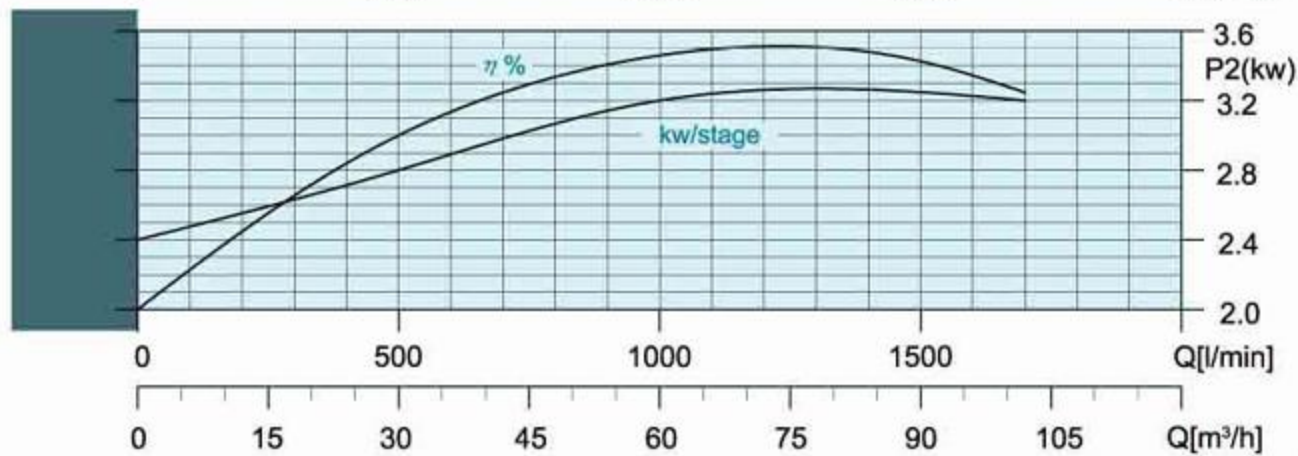
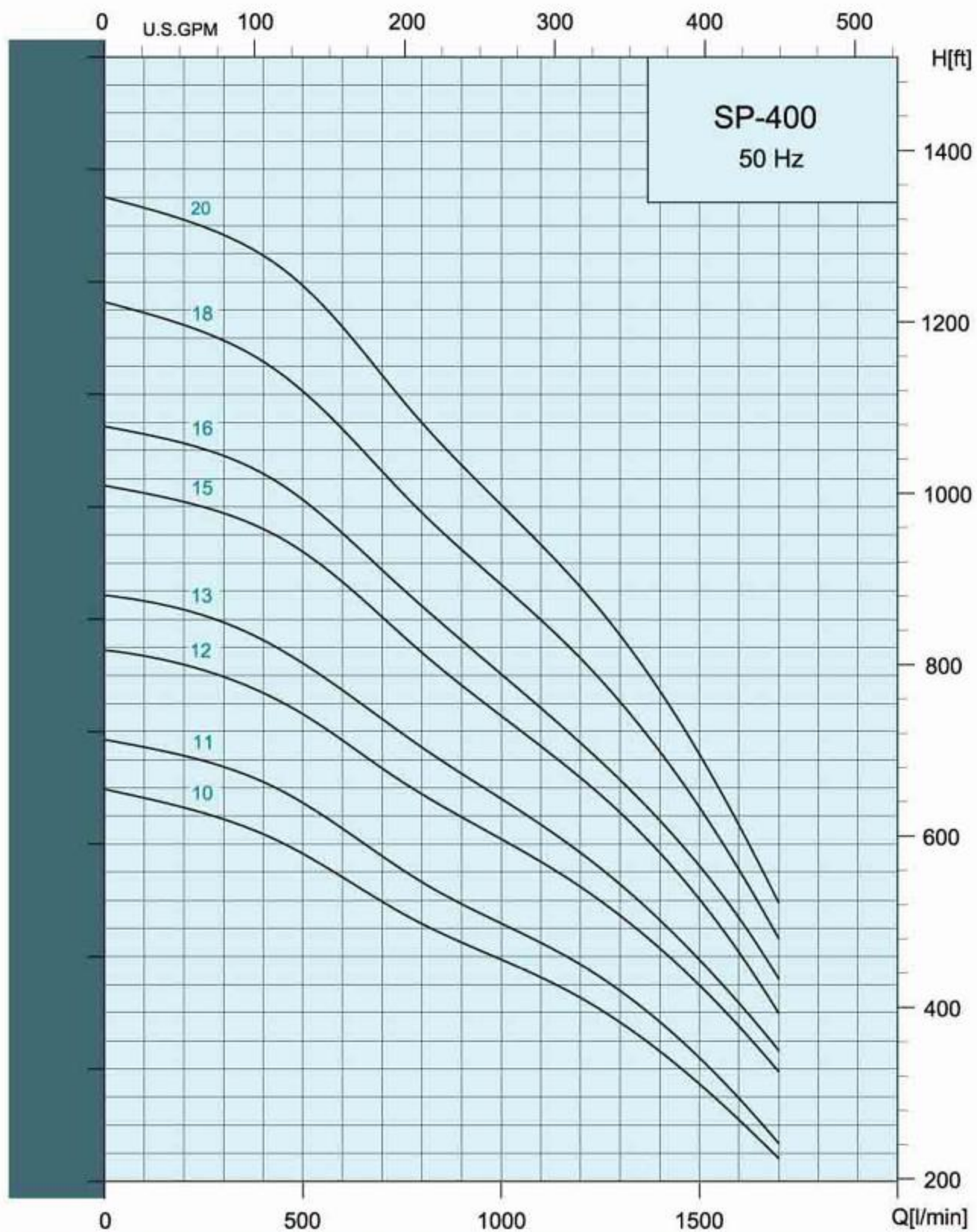

Stairs SP Series



STAIRS PUMPS

SP 8"

SP500 Performance Curves

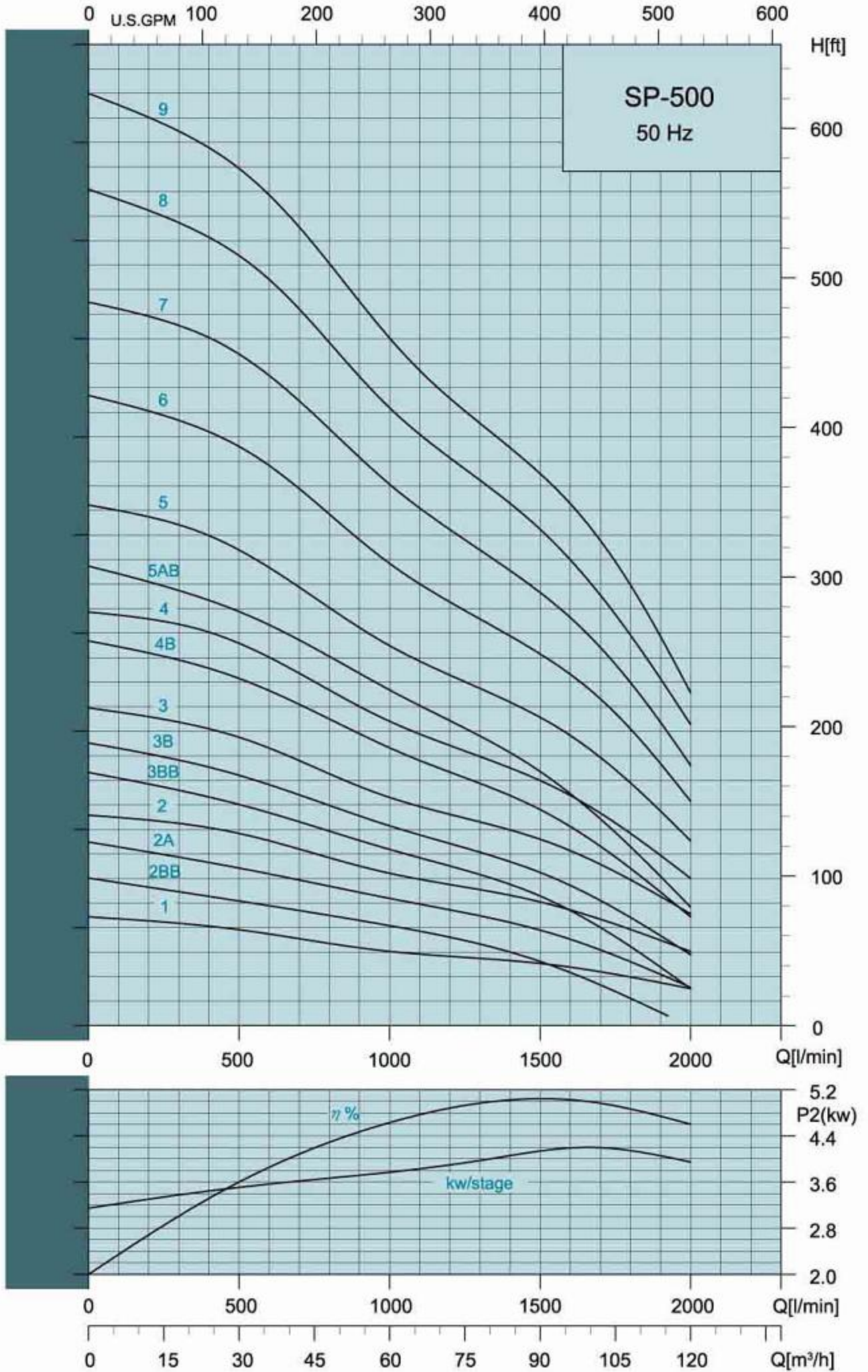



STAIRS PUMPS

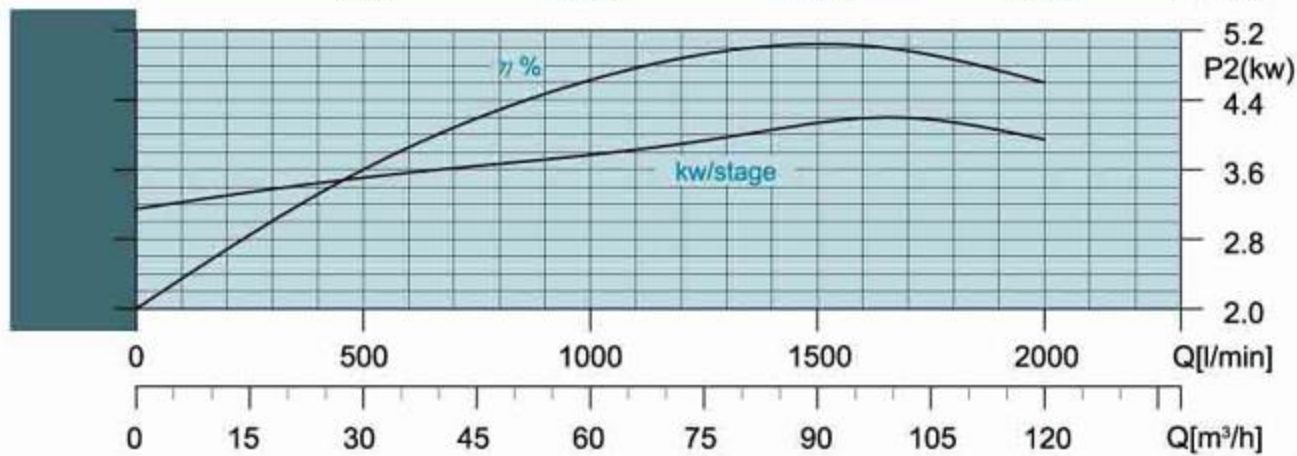
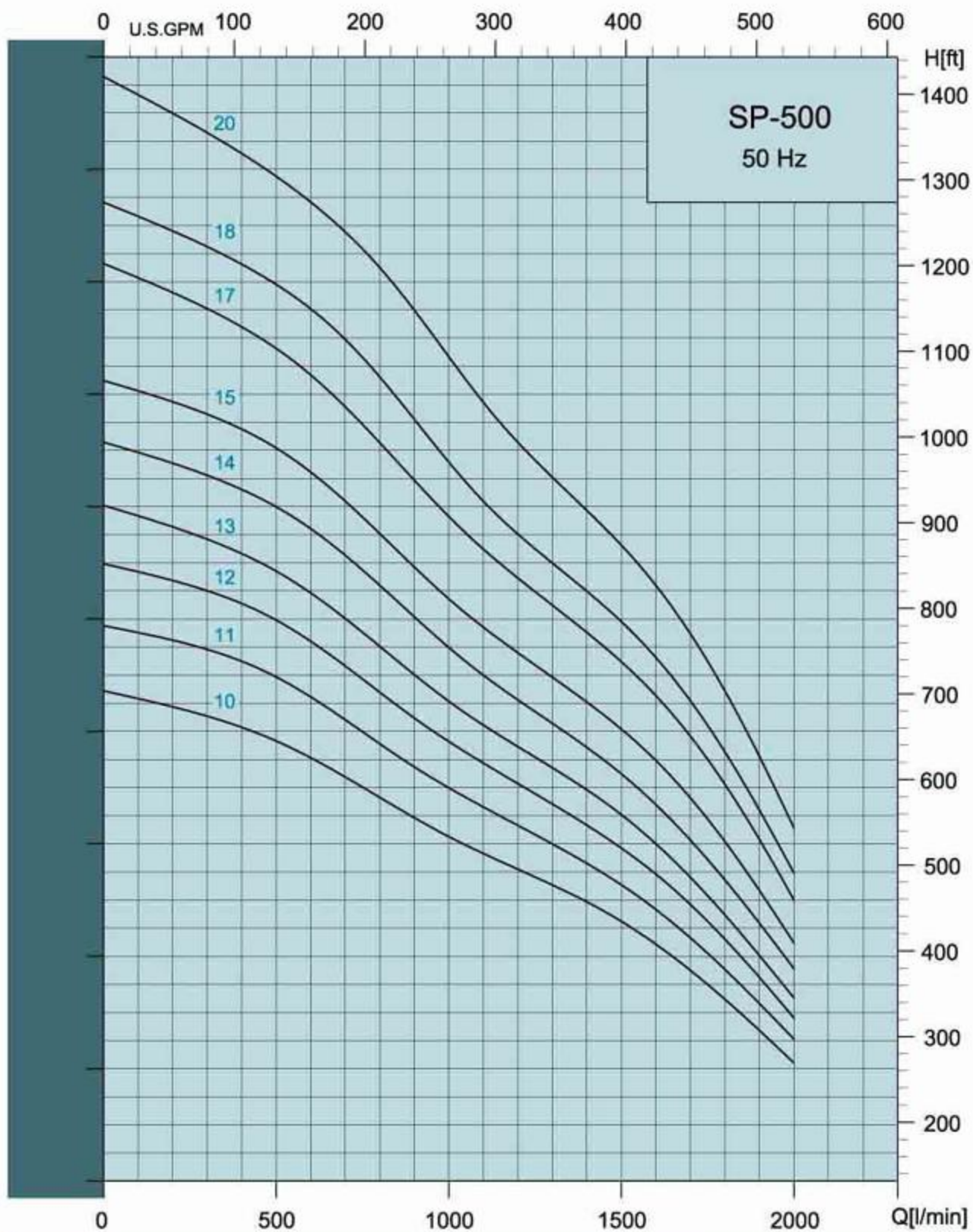

Stairs SP Series



SP 8"

SP400

Selection Chart

Pump Type	Motor		Max.current		m ³ /h l/min	Q capacity 2900 rpm											
	P2		Amp			12	18	24	30	36	42	48	54	66	78	90	102
	KW	HP	220V	380V		200	300	400	500	600	700	800	900	1100	1300	1500	1700
SP 400-1	5.5	7.5	21.9	12.7	20	19.5	19	18	17	16	15	14	13	12	9	7	
SP 400-2-B	5.5	7.5	21.9	12.7	33	32	30	28	27	26	25	23	20	16	11	6	
SP 400-2	7.5	10	28.5	16.5	38	37	36	35	33	32	30	28	26	23	18	13	
SP 400-3-B	9.3	12.5	36	20.9	53	51	49	47	45	43	40	38	34	28	22	13	
SP 400-3	11	15	41.8	24.2	58	57	55	53	50	47	45	43	39	35	28	20	
SP 400-4-B	13	17.5	50	29	72	70	68	65	62	59	56	53	47	40	31	20	
SP 400-4	15	20	55	32	77	76	74	71	67	64	61	58	53	46	37	27	
SP 400-5	18.5	25	69	40	96	94	92	88	84	80	76	73	66	57	46	33	
SP 400-6	22	30	81	47	116	113	110	106	101	96	92	88	80	70	56	40	
SP 400-7	26	35	96	56	136	133	130	126	120	115	109	104	93	81	65	47	
SP 400-8-B	26	35	96	56	147	143	139	134	129	123	117	112	101	87	69	47	
SP 400-8	30	40	111	64	153	150	146	141	135	129	123	117	105	93	75	53	
SP 400-9	30	40	111	64	171	167	163	158	152	145	138	131	118	104	84	58	
SP 400-10	37	50	138	80	193	188	183	177	168	160	152	145	132	117	94	68	
SP 400-11	37	50	138	80	211	207	202	195	186	176	167	159	145	128	104	74	
SP 400-12	45	60	154	89	244	240	234	227	217	207	198	190	173	154	130	99	
SP 400-13	55	75	192	111	263	259	252	244	235	224	214	205	187	166	139	107	
SP 400-15	55	75	192	111	302	298	292	284	273	260	248	237	215	191	160	120	
SP 400-16	63	85	240	139	322	318	312	302	290	278	265	252	228	202	172	132	
SP 400-18	63	85	240	139	365	359	352	341	328	312	298	285	260	230	193	147	
SP 400-20	75	100	256	148	402	397	389	379	364	347	330	315	287	254	212	159	

HEAD IN METERS

Dimensions And Weights

Pump Type	Dimensions(mm)						Net Weight(Kg)
	B 5" Connection (RP,NPT)			B 5" Flange			
	A	C*	C**	A	C*	C**	Pump
SP 400-1	618	178	186	618	200	200	25.1
SP 400-2-B	746	178	186	746	200	200	28.7
SP 400-2	746	178	186	746	200	200	28.7
SP 400-3-B	874	178	186	874	200	200	32.3
SP 400-3	874	178	186	874	200	200	32.3
SP 400-4-B	1003	178	186	1003	200	200	35.9
SP 400-4	1003	178	186	1003	200	200	35.9
SP 400-5	1131	178	186	1131	200	200	39.5
SP 400-6	1259	178	186	1259	200	200	43
SP 400-7	1387	178	186	1387	200	200	46.6
SP 400-8-B	1515	178	186	1515	200	200	50.2
SP 400-8	1515	178	186	1515	200	200	50.2
SP 400-9	1644	178	186	1644	200	200	53.8
SP 400-10	1772	178	186	1772	200	200	57.4
SP 400-11	1900	178	186	1900	200	200	61
SP 400-12	2039	200	204	2039	209	209	66
SP 400-13	2168	200	204	2168	209	209	69.6
SP 400-15	2424	200	204				76.8
SP 400-16	2552	200	204				80.4
SP 400-18	2809	200	204				87.6
SP 400-20	3065	200	204				94.8

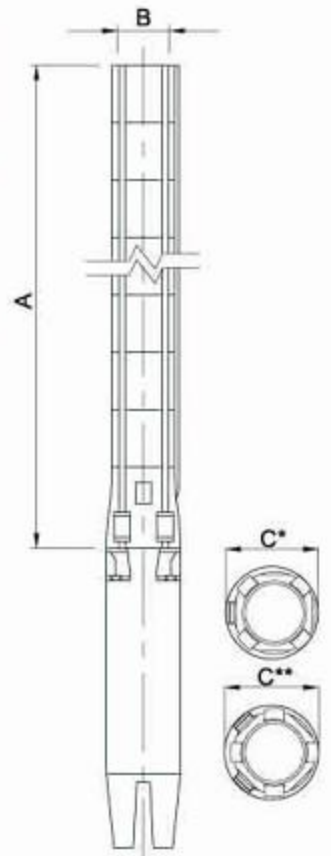

C*: Maximum diameter of pump with one motor cable
 C**: Maximum diameter of pump with two motor cable

SP 8"

SP500

Selection Chart

Pump Type	Motor		Max.current		m ³ /h l/min	Q capacity 2900 rpm											
	P2		Amp			18	24	30	36	42	48	60	72	84	96	108	120
	KW	HP	220V	380V		300	400	500	600	700	800	1000	1200	1400	1600	1800	2000
SP 500-1	5.5	7.5	21.9	12.7	HEAD IN METERS	21	20	19	18	17.5	17	15	14	13	12	10	8
SP 500-2-BB	5.5	7.5	21.9	12.7		27	26	25	24	23	22	20	18	15	11	5	0
SP 500-2-A	7.5	10	28.5	16.5		34	33	32	31	30	28	26	24	21	17	13	8
SP 500-2	9.3	12.5	36	20.9		41	40	39	37	36	34	31	29	26	23	20	15
SP 500-3-BB	9.3	12.5	36	20.9		48	46	45	43	41	40	36	33	28	23	16	8
SP 500-3-B	11	15	41.8	24.2		54	53	51	49	47	45	41	37	33	28	22	15
SP 500-3	13	17.5	50	29		62	60	59	57	54	51	47	43	40	35	30	23
SP 500-4-B	15	20	55	32		74	73	71	68	65	62	56	52	47	40	32	22
SP 500-4	18.5	25	69	40		82	80	78	75	72	68	62	57	53	47	39	30
SP 500-5-AB	18.5	25	69	40		89	87	84	82	78	75	68	62	55	47	36	25
SP 500-5	22	30	81	47		102	100	97	94	90	85	77	72	66	59	50	38
SP 500-6	26	35	96	56		123	121	118	114	110	104	94	86	79	72	60	46
SP 500-7	30	40	111	64		143	140	137	132	127	121	110	101	93	83	70	53
SP 500-8	37	50	138	80		164	160	157	152	146	139	126	116	106	95	80	62
SP 500-9	37	50	138	80		182	179	175	169	163	155	140	128	118	106	90	68
SP 500-10	45	60	154	89		206	201	197	190	183	177	162	150	140	124	105	82
SP 500-11	55	75	192	111		230	225	220	212	204	196	180	167	152	137	116	90
SP 500-12	55	75	192	111		250	245	240	231	222	214	197	181	167	150	126	99
SP 500-13	55	75	192	111		268	263	258	250	240	230	210	195	180	160	135	106
SP 500-14	63	85	240	139		291	286	280	271	261	251	230	210	194	174	147	116
SP 500-15	75	100	256	148	312	308	300	292	281	270	248	228	210	190	160	126	
SP 500-17	75	100	256	148	350	344	336	327	316	302	277	255	235	212	180	140	
SP 500-18	93	125	335	194	372	366	360	350	340	326	296	270	250	227	192	150	
SP 500-20	93	125	335	194	412	406	397	388	378	365	333	302	279	251	214	166	

Dimensions And Weights

Pump Type	Dimensions(mm)						Net Weight(Kg)
	B 5" Connection (RP,NPT)			B 5" Flange			
	A	C*	C**	A	C*	C**	Pump
SP 500-1	618	178	186	618	200	200	25.1
SP 500-2-BB	746	178	186	746	200	200	28.7
SP 500-2-A	746	178	186	746	200	200	28.7
SP 500-2	746	178	186	746	200	200	28.7
SP 500-3-BB	874	178	186	874	200	200	32.3
SP 500-3-B	874	178	186	874	200	200	32.3
SP 500-3	874	178	186	874	200	200	32.3
SP 500-4-B	1003	178	186	1003	200	200	35.9
SP 500-4	1003	178	186	1003	200	200	35.9
SP 500-5-AB	1131	178	186	1131	200	200	39.5
SP 500-5	1131	178	186	1131	200	200	39.5
SP 500-6	1259	178	186	1259	200	200	43
SP 500-7	1387	178	186	1387	200	200	46.6
SP 500-8	1515	178	186	1515	200	200	50.2
SP 500-9	1644	178	186	1644	200	200	53.8
SP 500-10	1783	196	204	1783	205	205	58.8
SP 500-11	1911	196	204	1911	205	205	62.4
SP 500-12	2039	196	204	2039	205	205	66
SP 500-13	2168	196	204	2168	205	205	69.6
SP 500-14	2296	196	204	2296	205	205	73.2
SP 500-15	2424	196	204				76.7
SP 500-17	2680	196	204				84
SP 500-18	2809	196	204				87.6
SP 500-20	3065	196	204				94.8

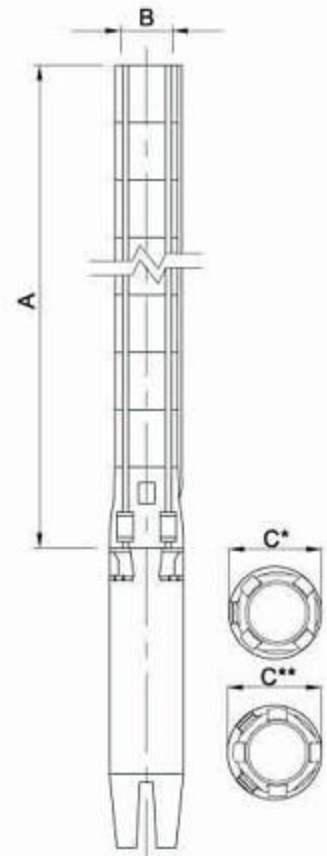

C*: Maximum diameter of pump with one motor cable
 C**: Maximum diameter of pump with two motor cable



STAIRS INDUSTRIAL CO., LTD.

Company

No. 3-8, Sanchial Tsun, Lutsao Hsiang,
Chiai Hsien, Taiwan, R.O.C.

Tel:+886(0)53751936

Fax:+886(0)53752330

E-Mail:stairs@stairs.com.tw